

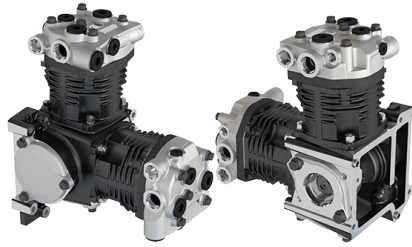

Application: 547 cc

OEM	OE
	51 54000 7114
	51 54000 7064
	51 54000 7075

Cylinder Bore	Ø90
Stroke	43 mm
Swept Volume	547 cc
Air Inlet Port Size	M26x1.5
Air Delivery Port Size	M26*1,5
Number of Cylinders	2
Through Drive	Yes
Unloader Port Size	-
Water Or Air Cooled	W
Water Inlet Port Size	M14x1.5
Water Delivery Port Size	M22x1.5
Water Cooled Valve Plate	Yes

Components

351.01.1100	Crankcase										
	<table border="1"> <thead> <tr> <th>OEM</th> <th>OE</th> </tr> </thead> <tbody> <tr> <td></td> <td>4471310115</td> </tr> <tr> <td></td> <td>4471310315</td> </tr> <tr> <td></td> <td>51541125013</td> </tr> <tr> <td></td> <td>51541126008</td> </tr> </tbody> </table>	OEM	OE		4471310115		4471310315		51541125013		51541126008
OEM	OE										
	4471310115										
	4471310315										
	51541125013										
	51541126008										

342.01.1200	Cylinder Head										
	<table border="1"> <thead> <tr> <th>OEM</th> <th>OE</th> </tr> </thead> <tbody> <tr> <td></td> <td>4071300219</td> </tr> <tr> <td></td> <td>4071300519</td> </tr> <tr> <td></td> <td>4421303119</td> </tr> <tr> <td></td> <td>4421303119</td> </tr> </tbody> </table>	OEM	OE		4071300219		4071300519		4421303119		4421303119
OEM	OE										
	4071300219										
	4071300519										
	4421303119										
	4421303119										

342.01.1210	Cylinder Head With Plate Kit				
	<table border="1"> <thead> <tr> <th>OEM</th> <th>OE</th> </tr> </thead> <tbody> <tr> <td></td> <td>4071300719</td> </tr> </tbody> </table>	OEM	OE		4071300719
OEM	OE				
	4071300719				

342.01.1300	Plate Kit						
	<table border="1"> <thead> <tr> <th>OEM</th> <th>OE</th> </tr> </thead> <tbody> <tr> <td></td> <td>4411300220</td> </tr> <tr> <td></td> <td>4421300220</td> </tr> </tbody> </table>	OEM	OE		4411300220		4421300220
OEM	OE						
	4411300220						
	4421300220						

351.01.1400	Connecting Rod				
	<table border="1"> <thead> <tr> <th>OEM</th> <th>OE</th> </tr> </thead> <tbody> <tr> <td></td> <td>51541066015</td> </tr> </tbody> </table>	OEM	OE		51541066015
OEM	OE				
	51541066015				

351.01.1410	Crankpin Bearing				
	<table border="1"> <thead> <tr> <th>OEM</th> <th>OE</th> </tr> </thead> <tbody> <tr> <td></td> <td>51541216002</td> </tr> </tbody> </table>	OEM	OE		51541216002
OEM	OE				
	51541216002				

351.01.1500	Crankshaft				
	<table border="1"> <thead> <tr> <th>OEM</th> <th>OE</th> </tr> </thead> <tbody> <tr> <td></td> <td>51541130021</td> </tr> </tbody> </table>	OEM	OE		51541130021
OEM	OE				
	51541130021				

340.01.1600	Bearing Cover						
	<table border="1"> <thead> <tr> <th>OEM</th> <th>OE</th> </tr> </thead> <tbody> <tr> <td></td> <td>4031301645</td> </tr> <tr> <td></td> <td>51541306011</td> </tr> </tbody> </table>	OEM	OE		4031301645		51541306011
OEM	OE						
	4031301645						
	51541306011						

340.01.1620	Bearing Cover						
	<table border="1"> <thead> <tr> <th>OEM</th> <th>OE</th> </tr> </thead> <tbody> <tr> <td></td> <td>4031301645</td> </tr> <tr> <td></td> <td>51541306011</td> </tr> </tbody> </table>	OEM	OE		4031301645		51541306011
OEM	OE						
	4031301645						
	51541306011						

340.01.2900	Gear										
	<table border="1"> <thead> <tr> <th>OEM</th> <th>OE</th> </tr> </thead> <tbody> <tr> <td></td> <td>4071321005</td> </tr> <tr> <td></td> <td>4071321105</td> </tr> <tr> <td></td> <td>4661320005</td> </tr> <tr> <td></td> <td>51542100038</td> </tr> </tbody> </table>	OEM	OE		4071321005		4071321105		4661320005		51542100038
OEM	OE										
	4071321005										
	4071321105										
	4661320005										
	51542100038										

351.01.1700	Piston With Rings (STD)												
	<table border="1"> <thead> <tr> <th>OEM</th> <th>OE</th> </tr> </thead> <tbody> <tr> <td></td> <td>351.01.1700-Ø90.00 mm</td> </tr> <tr> <td></td> <td>351.01.1710-Ø90.25 mm</td> </tr> <tr> <td></td> <td>351.01.1720-Ø90.50 mm</td> </tr> <tr> <td></td> <td>351.01.1730-Ø90.75 mm</td> </tr> <tr> <td></td> <td>351.01.1740-Ø91.00 mm</td> </tr> </tbody> </table>	OEM	OE		351.01.1700-Ø90.00 mm		351.01.1710-Ø90.25 mm		351.01.1720-Ø90.50 mm		351.01.1730-Ø90.75 mm		351.01.1740-Ø91.00 mm
OEM	OE												
	351.01.1700-Ø90.00 mm												
	351.01.1710-Ø90.25 mm												
	351.01.1720-Ø90.50 mm												
	351.01.1730-Ø90.75 mm												
	351.01.1740-Ø91.00 mm												

340.01.1800	Piston Ring Kit (STD)					
	<table border="1"> <thead> <tr> <th>OEM</th> <th>OE</th> </tr> </thead> <tbody> <tr> <td></td> <td>4111426232</td> </tr> </tbody> </table>	OEM	OE		4111426232	
OEM	OE					
	4111426232					
	<table border="1"> <tbody> <tr> <td>340.01.1800-Ø90.00 mm</td> </tr> <tr> <td>340.01.1810-Ø90.25 mm</td> </tr> <tr> <td>340.01.1820-Ø90.50 mm</td> </tr> <tr> <td>340.01.1830-Ø90.75 mm</td> </tr> <tr> <td>340.01.1840-Ø91.00 mm</td> </tr> </tbody> </table>	340.01.1800-Ø90.00 mm	340.01.1810-Ø90.25 mm	340.01.1820-Ø90.50 mm	340.01.1830-Ø90.75 mm	340.01.1840-Ø91.00 mm
340.01.1800-Ø90.00 mm						
340.01.1810-Ø90.25 mm						
340.01.1820-Ø90.50 mm						
340.01.1830-Ø90.75 mm						
340.01.1840-Ø91.00 mm						

342.01.2300 Repair Kit With Bushing



OEM	OE

342.01.2350 Repair Kit w/o Bushing

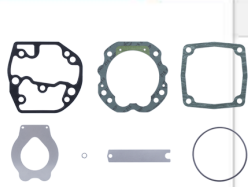

OEM	OE

342.01.1280 Head Repair Kit



OEM	OE

342.01.2100 Gasket & Sealing Kit



OEM	OE

340.01.2200 Valve Kit



OEM	OE

318.01.1502 Screw for crankshaft



OEM	OE

4039900610
51900200131

340.01.2600 Bushing



OEM	OE

4031310450
51930200335

340.01.2800 Cylinder Liner



OEM	OE

STW63740 4021300308

354.01.2810 Cylinder Liner Kit



OEM	OE

51541066008

334.01.3600 Cover Square



OEM	OE

4421310021
51014020033

334.01.3700 Cover Triangle



OEM	OE

4071310021
51541110001

340.01.2700 Screw Kit



OEM	OE

343.01.1310 Plate Kit, Complete

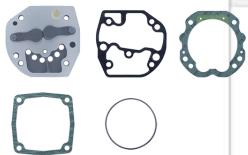

OEM	OE

OEM	OE

OEM	OE