

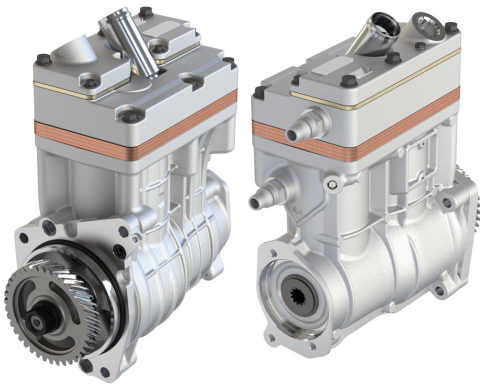









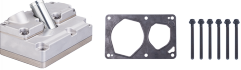
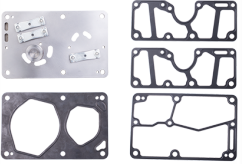

**Application:** OM 936 / TOURISMO / CITARO



OEM	OE
LP490	936 130 08 15
14900028513	936 130 09 15
14900028512	936 130 31 15
14900028511	001 130 41 15
14900028510	001 130 61 15
14900105410	001 130 63 15
14900119510	001 130 65 15
14900128010	001 130 90 15
14900128011	001 130 94 15
14900146010	002 130 43 15
14900146011	471 130 07 15
14900184510	471 130 10 15
14900184610	470 130 00 15
14900184710	471 130 04 15
	471 130 00 15
	471 130 20 15
	471 130 33 15
	471 130 35 15
	471 130 41 15
	471 130 43 15
	936 130 22 15

<b>Cylinder Bore</b>	Ø92 / Ø60
<b>Stroke</b>	60 / 30 mm
<b>Swept Volume</b>	490 cc
<b>Air Inlet Port Size</b>	Ø34.5
<b>Air Delivery Port Size</b>	M26x1,5
<b>Number of Cylinders</b>	2
<b>Through Drive</b>	Yes
<b>Unloader Port Size</b>	-
<b>Water Or Air Cooled</b>	W
<b>Water Inlet Port Size</b>	M18x1.5
<b>Water Delivery Port Size</b>	M18x1.5
<b>Water Cooled Valve Plate</b>	Yes

## Components

<b>543.01.1100</b> Crankcase  <table border="1"> <thead> <tr><th>OEM</th><th>OE</th></tr> </thead> <tbody> <tr><td> </td><td> </td></tr> </tbody> </table>	OEM	OE			<b>543.01.1220</b> Cylinder Upper Head  <table border="1"> <thead> <tr><th>OEM</th><th>OE</th></tr> </thead> <tbody> <tr><td> </td><td> </td></tr> </tbody> </table>	OEM	OE			<b>543.01.1230</b> Cylinder Lower Head  <table border="1"> <thead> <tr><th>OEM</th><th>OE</th></tr> </thead> <tbody> <tr><td> </td><td> </td></tr> </tbody> </table>	OEM	OE		
OEM	OE													
OEM	OE													
OEM	OE													
<b>543.01.1210</b> Cylinder Head With Plate Kit  <table border="1"> <thead> <tr><th>OEM</th><th>OE</th></tr> </thead> <tbody> <tr><td> </td><td> </td></tr> </tbody> </table>	OEM	OE			<b>543.01.1300</b> Plate Kit  <table border="1"> <thead> <tr><th>OEM</th><th>OE</th></tr> </thead> <tbody> <tr><td> </td><td>0011308815</td></tr> </tbody> </table>	OEM	OE		0011308815	<b>505.01.1400</b> Connecting Rod  <table border="1"> <thead> <tr><th>OEM</th><th>OE</th></tr> </thead> <tbody> <tr><td> </td><td> </td></tr> </tbody> </table>	OEM	OE		
OEM	OE													
OEM	OE													
	0011308815													
OEM	OE													
<b>505.01.1460</b> Connecting Rod  <table border="1"> <thead> <tr><th>OEM</th><th>OE</th></tr> </thead> <tbody> <tr><td> </td><td> </td></tr> </tbody> </table>	OEM	OE			<b>544.01.1500</b> Crankshaft  <table border="1"> <thead> <tr><th>OEM</th><th>OE</th></tr> </thead> <tbody> <tr><td> </td><td> </td></tr> </tbody> </table>	OEM	OE			<b>544.01.1510</b> Adapter  <table border="1"> <thead> <tr><th>OEM</th><th>OE</th></tr> </thead> <tbody> <tr><td> </td><td> </td></tr> </tbody> </table>	OEM	OE		
OEM	OE													
OEM	OE													
OEM	OE													
<b>543.01.1650</b> Front Flange  <table border="1"> <thead> <tr><th>OEM</th><th>OE</th></tr> </thead> <tbody> <tr><td> </td><td> </td></tr> </tbody> </table>	OEM	OE			<b>505.01.1700</b> Piston With Rings (STD)  505.01.1700-Ø92.00 mm 505.01.1750-Ø60.00 mm <table border="1"> <thead> <tr><th>OEM</th><th>OE</th></tr> </thead> <tbody> <tr><td> </td><td> </td></tr> </tbody> </table>	OEM	OE			<b>505.01.1800</b> Piston Ring Kit (STD)  505.01.1800-Ø92.00 mm 505.01.1850-Ø60.00 mm <table border="1"> <thead> <tr><th>OEM</th><th>OE</th></tr> </thead> <tbody> <tr><td> </td><td> </td></tr> </tbody> </table>	OEM	OE		
OEM	OE													
OEM	OE													
OEM	OE													

543.01.2800 Cylinder Liner		OEM	OE
			

543.01.2810 Cylinder Liner Kit		OEM	OE
			

543.01.2850 Cylinder Liner		OEM	OE
			

543.01.2860 Cylinder Liner & Piston w Rings		OEM	OE
			

543.01.2350 Repair Kit w/o Bushing		OEM	OE
			

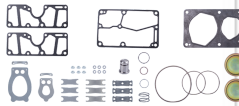
543.01.2330 Repair Kit		OEM	OE
			

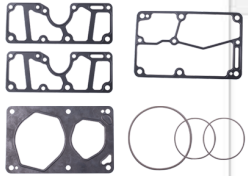
543.01.2100 Gasket & Sealing Kit		OEM	OE
			

505.01.2200 Valve Kit		OEM	OE
			

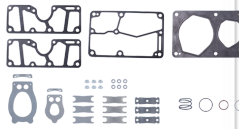
543.01.1280 Head Repair Kit		OEM	OE
			

487.01.2900 Gear		OEM	OE
			9361320305

505.01.1900 Cap		OEM	OE
			

		OEM	OE

		OEM	OE

		OEM	OE

		OEM	OE

		OEM	OE

		OEM	OE

		OEM	OE