

585.01.1000

Compressor (Single Cylinder)

Application: CATERPILLAR ENGINE 3126 / C7 & C9

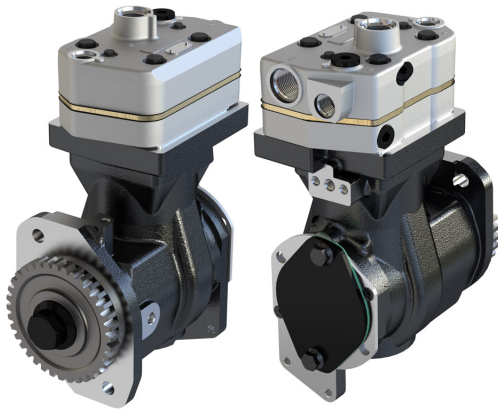

OEM	OE
9111545180	224-0003
9111545120	

Cylinder Bore	Ø75
Stroke	56
Swept Volume	247
Air Inlet Port Size	1/16'-12UN2B
Air Delivery Port Size	1/16'-12UN2B
Number of Cylinders	1
Through Drive	YES
Unloader Port Size	1/8'-27 NPTF
Water Or Air Cooled	W
Water Inlet Port Size	3/4'-16UNF-2B
Water Delivery Port Size	3/4'-16UNF-2B
Water Cooled Valve Plate	YES

Components

585.01.1100 Crankcase

	OEM	OE

583.01.1200 Cylinder Head

	OEM	OE
	9111549342	3975352 4089686 4946290 4988936

583.01.1220 Cylinder Upper Head

	OEM	OE

599.01.1230 Cylinder Lower Head

	OEM	OE

599.01.1300 Coolant Plate

	OEM	OE

585.01.1400 Connecting Rod

	OEM	OE

585.01.1500 Crankshaft

	OEM	OE

602.01.1510 Pump Adapter

	OEM	OE
	9119022304	4089677

235.01.1103 Bearing

	OEM	OE

602.01.1600 Bearing Cover

	OEM	OE
	9111539252	4089222 4089222

218.01.1700 Piston With Rings (STD)

	OEM	OE
	4111416232	513860 8121570 9982648 5000816053 0001311607 81541190004 81541196039
218.01.1700-Ø75.00 mm		
218.01.1710-Ø75.25 mm		
218.01.1720-Ø75.50 mm		
218.01.1730-Ø75.75 mm		
218.01.1740-Ø76.00 mm		

102.01.1800 Piston Ring Kit (STD)

	OEM	OE
	4111416232	513839
102.01.1800-Ø75.00 mm	1801770061	513843
102.01.1810-Ø75.25 mm	8956710204	1283826
102.01.1820-Ø75.50 mm	4111419202	1391384
102.01.1830-Ø75.75 mm		1391385
102.01.1840-Ø76.00 mm		1396835
		3090388
		0011310711

**585.01.2300 Repair Kit With Bushing**

	OEM	OE

**599.01.2350 Repair Kit w/o Bushing**

	OEM	OE

**585.01.2310 Repair Kit With Bushing & Plate**

	OEM	OE

**599.01.2330 Repair Kit**

	OEM	OE

**599.01.1280 Head Repair Kit**

	OEM	OE

**599.01.2100 Gasket & Sealing Kit**

	OEM	OE

**599.01.2200 Valve Kit**

	OEM	OE

**599.01.2500 Unloader Valve Kit**

	OEM	OE

**619.01.2600 Bushing**

	OEM	OE

**585.01.2900 Gear**

	OEM	OE

**136.01.1900 Cap**

	OEM	OE
	8950735894	1304881 3094835 11712508 0001312321

**136.01.2700 Screw Kit**

	OEM	OE
	8912119994	

	OEM	OE

	OEM	OE

	OEM	OE

	OEM	OE

	OEM	OE

	OEM	OE

Application: 247 cc

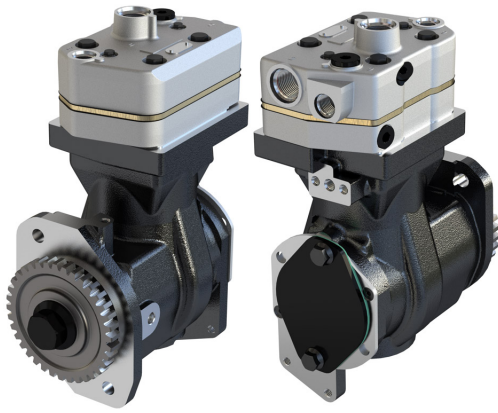

OEM	OE
9111545060	193-3940

Cylinder Bore	Ø75
Stroke	56 mm
Swept Volume	247 cc
Air Inlet Port Size	Ø25
Air Delivery Port Size	M27*2
Number of Cylinders	1
Through Drive	Yes
Unloader Port Size	-
Water Or Air Cooled	W
Water Inlet Port Size	3/4"- 16 UNF
Water Delivery Port Size	3/4"- 16 UNF
Water Cooled Valve Plate	Yes

## Components

**599.01.1200** Cylinder Head

OEM	OE
9111549202	4089208

**599.01.1220** Cylinder Upper Head

OEM	OE

**599.01.1230** Cylinder Lower Head

OEM	OE

**599.01.1300** Coolant Plate

OEM	OE

**602.01.1600** Bearing Cover

OEM	OE
9111539252	4089222 4089222

**136.01.1900** Cap

OEM	OE
8950735894	1304881 3094835 11712508 0001312321

**599.01.2700** Screw Kit

OEM	OE

**599.01.1280** Head Repair Kit

OEM	OE

**218.01.1700** Piston With Rings (STD)

OEM	OE
4111416232	513860 8121570 9982648 5000816053 0001311607 81541190004 81541196039

218.01.1700-Ø75.00 mm  
218.01.1710-Ø75.25 mm  
218.01.1720-Ø75.50 mm  
218.01.1730-Ø75.75 mm  
218.01.1740-Ø76.00 mm

**102.01.1800** Piston Ring Kit (STD)

OEM	OE
4111416232	513839
1801770061	513843
8956710204	1283826
4111419202	1391384 1391385 1396835 3090388 0011310711

102.01.1800-Ø75.00 mm  
102.01.1810-Ø75.25 mm  
102.01.1820-Ø75.50 mm  
102.01.1830-Ø75.75 mm  
102.01.1840-Ø76.00 mm

**599.01.2200** Valve Kit

OEM	OE

**599.01.2500** Unloader Valve Kit

OEM	OE

599.01.2350 Repair Kit w/o Bushing

	OEM	OE
		

599.01.2330 Repair Kit

	OEM	OE
		

599.01.2100 Gasket & Sealing Kit

	OEM	OE
		

	OEM	OE

	OEM	OE

	OEM	OE

	OEM	OE

	OEM	OE

	OEM	OE

	OEM	OE

	OEM	OE

	OEM	OE

	OEM	OE

	OEM	OE

	OEM	OE

	OEM	OE

	OEM	OE

	OEM	OE

**637.01.1000**

**Compressor (Twin Cylinder)**

**Application:** TRUCK C10 C12 - INDUSTRIAL 3176C 3196 C10 C12

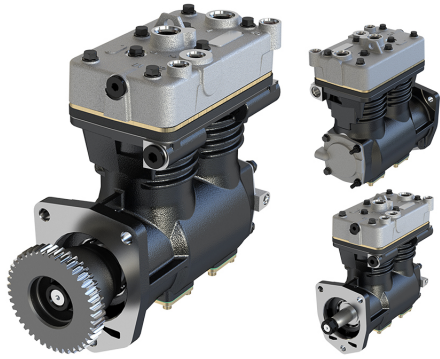

**637.01.1000**

**637.01.2000  
(WITHOUT GEAR)**

OEM	OE
DURA-FLO596	163-6365
LP4981	0R-9901
II37437	0R-9903
5007099	163-6367
5007096	
5007095	
5007085	
5007077	
5007076	
5004717	
5004713	
800703	
800696	
K046148	

<b>Cylinder Bore</b>	Ø88
<b>Stroke</b>	50
<b>Swept Volume</b>	608
<b>Air Inlet Port Size</b>	1/16'-12UN2B
<b>Air Delivery Port Size</b>	1/16'-12UN2B
<b>Number of Cylinders</b>	2
<b>Through Drive</b>	YES
<b>Unloader Port Size</b>	M22x1.5
<b>Water Or Air Cooled</b>	W
<b>Water Inlet Port Size</b>	3/4'-16UNF-2B
<b>Water Delivery Port Size</b>	3/4'-16UNF-2B
<b>Water Cooled Valve Plate</b>	YES

## Components

**637.01.1100 Crankcase**

	OEM	OE

**637.01.1200 Cylinder Head**

	OEM	OE

**637.01.1210 Cylinder Head With Plate Kit**

	OEM	OE

**110.01.1400 Connecting Rod**

	OEM	OE
	SEB00967004	3097151

**637.01.1500 Crankshaft**

	OEM	OE

**636.01.1580 Nut For Crankshaft**

	OEM	OE

**637.01.1600 Bearing Cover**

	OEM	OE

**637.01.1103 Bearing**

	OEM	OE

**637.01.2900 Gear**

	OEM	OE

**110.01.2700 Screw Kit**

	OEM	OE

**110.01.1700 Piston With Rings (STD)**

	OEM	OE
	SEB22555 I81169004	1361265 1409318 1698848 3095841 51541036001 81541190007 85101375
110.01.1700-Ø88.00 mm		
110.01.1710-Ø88.25 mm		
110.01.1720-Ø88.50 mm		
110.01.1730-Ø88.75 mm		
110.01.1740-Ø89.00 mm		

**110.01.1800 Piston Ring Kit (STD)**

	OEM	OE
	I811690062 II39526F0061	3097153 85100626
110.01.1800-Ø88.00 mm		
110.01.1810-Ø88.25 mm		
110.01.1820-Ø88.50 mm		
110.01.1830-Ø88.75 mm		
110.01.1840-Ø89.00 mm		

110.01.2350 Repair Kit w/o Bushing		OEM	OE
		SEB22560 SEB22596	

110.01.2320 Repair Kit		OEM	OE

110.01.1280 Head Repair Kit		OEM	OE

110.01.2100 Gasket & Sealing Kit		OEM	OE
		SEB22561	1376281 1542159 3097143

110.01.1300 Plate Kit		OEM	OE
		SEB01033004	1376272 3097146

110.01.1310 Plate Kit, Complete		OEM	OE

110.01.2200 Valve Kit		OEM	OE
		SEB01138004 II326840061	1376280 1391386 3091718 3091739

102.01.2500 Unloader Valve Kit		OEM	OE
		II159920063	1376279 3097147

102.01.1900 Bottom Cover Kit		OEM	OE
		EB01058	1283816 1697772

		OEM	OE

		OEM	OE

		OEM	OE

		OEM	OE

		OEM	OE

		OEM	OE

		OEM	OE

		OEM	OE

		OEM	OE

**650.01.1000**

**Compressor (Single Cylinder)**

Application: 143 cc



OEM	OE
	2P-8711 1W-6753

## Components

**650.01.1100** Crankcase

OEM	OE
	1W6471

**650.01.1200** Cylinder Head

OEM	OE
	

**650.01.1210** Cylinder Head With Plate Kit

OEM	OE
	7N2833

**650.01.1300** Plate

OEM	OE
	

**650.01.1400** Connecting Rod

OEM	OE
	8A2248

**650.01.1500** Crankshaft

OEM	OE
	2P7850

**650.01.1600** Bearing Cover

OEM	OE
	1P5480

**650.01.1700** Piston With Rings (STD)

OEM	OE
	
650.01.1700-Ø66.70 mm	

**650.01.1800** Piston Ring Kit (STD)

OEM	OE
	
650.01.1800-Ø66.70 mm	

**650.01.2800** Cylinder Liner

OEM	OE
	8A2251

**650.01.2810** Cylinder Liner Kit

OEM	OE
	

**650.01.2350** Repair Kit w/o Bushing

OEM	OE
	

650.01.2100 Gasket & Sealing Kit

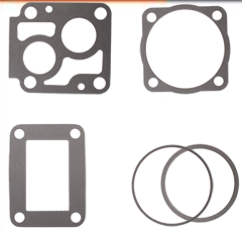

OEM	OE

650.06.100 Unloader Valve



OEM	OE

OEM	OE

OEM	OE

OEM	OE

OEM	OE

OEM	OE

OEM	OE

OEM	OE

OEM	OE

OEM	OE

OEM	OE

OEM	OE

OEM	OE

OEM	OE

OEM	OE

OEM	OE

OEM	OE



655.01.1000

Compressor (Single Cylinder)

Application: PHASER ENGINE



OEM	OE
LK3835	2488A293
SEB01599	451-1179

Cylinder Bore	Ø80
Stroke	45
Swept Volume	225
Air Inlet Port Size	M26x1.5
Air Delivery Port Size	M22x1.5
Number of Cylinders	1
Through Drive	YES
Unloader Port Size	M10x1
Water Or Air Cooled	W
Water Inlet Port Size	M16x1.5
Water Delivery Port Size	M16x1.5
Water Cooled Valve Plate	YES

Components

**656.01.1100** Crankcase

OEM	OE
	

**702.01.1200** Cylinder Head

OEM	OE
	SEB01763004 SEB01814004
	9P918392

**702.01.1210** Cylinder Head With Plate Kit

OEM	OE
	

**620.01.1300** Plate Kit

OEM	OE
	SEB01593004 SEB22461
	9P918391

**409.01.1400** Connecting Rod

OEM	OE
	SEB22464
	85104324

**655.01.1500** Crankshaft

OEM	OE
	

**620.01.1580** Nut For Crankshaft

OEM	OE
	

**655.01.1600** Bearing Cover

OEM	OE
	

**102.01.2600** Bushing

OEM	OE
	EB00819
	1315274 1697278 1697286 5001830853 1697286

**120.01.1900** Bottom Cover Kit

OEM	OE
	

**120.01.1700** Piston With Rings (STD)

OEM	OE
	SEB22517 SEB01594004
	1452718 1844254 42549206 85104325 7421136656 9P918388
	120.01.1700-Ø80.00 mm 120.01.1710-Ø80.25 mm 120.01.1720-Ø80.50 mm 120.01.1730-Ø80.75 mm 120.01.1740-Ø81.00 mm

**120.01.1800** Piston Ring Kit (STD)

OEM	OE
	SEB22463
	120.01.1800-Ø80.00 mm 120.01.1810-Ø80.25 mm 120.01.1820-Ø80.50 mm 120.01.1830-Ø80.75 mm 120.01.1840-Ø81.00 mm

**701.01.2300** Repair Kit With Bushing

	OEM	OE

**701.01.2350** Repair Kit w/o Bushing

	OEM	OE

**701.01.2330** Repair Kit

	OEM	OE
	SEB22519	

**701.01.2320** Repair Kit

	OEM	OE

**701.01.2340** Repair Kit

	OEM	OE

**701.01.1280** Head Repair Kit

	OEM	OE

**434.01.2100** Gasket & Sealing Kit

	OEM	OE

**120.01.2200** Valve Kit

	OEM	OE

**620.01.2500** Unloader Valve Kit

	OEM	OE
	I138147F0061	5411307715

**120.01.2700** Screw Kit

	OEM	OE

	OEM	OE

	OEM	OE

	OEM	OE

	OEM	OE

	OEM	OE

	OEM	OE

	OEM	OE

	OEM	OE

670.01.1000

Compressor (Single Cylinder)

Application: CATERPILLAR ENGINE C15 ACERT / C18 ACERT



OEM	OE
BA-921	304-9991
5012533	353-7137
5011427	385-0937
5012531	20R-0178
5012532	0R-1624
801463	223-3637
K209254	
K209255	
K020283	
K020284	
K020285	
K048941	
K048942	
K048943	
K066812	
K066832	
K066838	

<b>Cylinder Bore</b>	Ø92
<b>Stroke</b>	54
<b>Swept Volume</b>	358
<b>Air Inlet Port Size</b>	3/16'-12UN2B
<b>Air Delivery Port Size</b>	7/8'-14 UNF
<b>Number of Cylinders</b>	1
<b>Through Drive</b>	YES
<b>Unloader Port Size</b>	1/8'-27 NPT
<b>Water Or Air Cooled</b>	W
<b>Water Inlet Port Size</b>	3/4'-16UNF-2B
<b>Water Delivery Port Size</b>	3/4'-16UNF-2B
<b>Water Cooled Valve Plate</b>	YES

Components

**670.01.1100 Crankcase**

OEM	OE
	5011432



**670.01.1200 Cylinder Head**

OEM	OE



**670.01.1220 Cylinder Upper Head**

OEM	OE



**670.01.1230 Cylinder Lower Head**

OEM	OE
SEB01728004	42471272



**670.01.1210 Cylinder Head With Plate Kit**

OEM	OE



**670.01.1300 Plate Kit**

OEM	OE



**670.01.1400 Connecting Rod**

OEM	OE



**670.01.1500 Crankshaft**

OEM	OE



**670.01.1600 Bearing Cover**

OEM	OE



**670.01.1610 Bearing Cover**

OEM	OE



**122.01.1700 Piston With Rings (STD)**

OEM	OE
SEB22530	21136690
K006026	7421136690
K012079	51541196008
	51541196009



122.01.1700-Ø92.00 mm  
 122.01.1710-Ø92.25 mm  
 122.01.1720-Ø92.50 mm  
 122.01.1730-Ø92.75 mm  
 122.01.1740-Ø93.00 mm

**122.01.1800 Piston Ring Kit (STD)**

OEM	OE



122.01.1800-Ø92.00 mm  
 122.01.1810-Ø92.25 mm  
 122.01.1820-Ø92.50 mm  
 122.01.1830-Ø92.75 mm  
 122.01.1840-Ø93.00 mm

670.01.2300 Repair Kit With Bushing		OEM	OE

670.01.2350 Repair Kit w/o Bushing		OEM	OE

670.01.2330 Repair Kit		OEM	OE

670.01.2320 Repair Kit		OEM	OE

670.01.1280 Head Repair Kit		OEM	OE

670.01.2100 Gasket & Sealing Kit		OEM	OE

265.01.2200 Valve Kit		OEM	OE

670.01.2500 Unloader Valve Kit		OEM	OE
		K034874K50	

670.01.2600 Bushing		OEM	OE
		5010767	5010767

670.01.2900 Gear		OEM	OE
			F5733X0

235.01.1103 Bearing		OEM	OE

120.01.1900 Bottom Cover Kit		OEM	OE

670.01.1502 Screw for Crankshaft		OEM	OE

130.01.2700 Screw Kit		OEM	OE

		OEM	OE

		OEM	OE

		OEM	OE

		OEM	OE

Application: CATERPILLAR ENGINE C11 ACERT / C13 ACERT

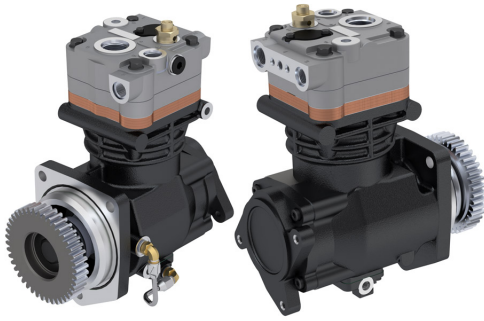

OEM	OE
BA-921	K048939
5014428	K048940
5011441	K056647
5012459	K056649
5012464	K066811
5012510	K066831
5014177	K066837
5014180	K056646
5014235	K209328
5014236	K209329
5014401	
5014402	
5014427	
801465	
801798	
801826	
K048938	

Cylinder Bore	Ø92
Stroke	54
Swept Volume	358
Air Inlet Port Size	3/16'-12UN2B
Air Delivery Port Size	7/8'-14 UNF
Number of Cylinders	1
Through Drive	YES
Unloader Port Size	1/8'-27 NPT
Water Or Air Cooled	W
Water Inlet Port Size	3/4'-16UNF-2B
Water Delivery Port Size	3/4'-16UNF-2B
Water Cooled Valve Plate	YES

## Components

**670.01.1100** Crankcase

OEM	OE
	5011432



**670.01.1200** Cylinder Head

OEM	OE



**670.01.1220** Cylinder Upper Head

OEM	OE



**670.01.1230** Cylinder Lower Head

OEM	OE
SEB01728004	42471272



**670.01.1210** Cylinder Head With Plate Kit

OEM	OE



**670.01.1300** Plate Kit

OEM	OE



**670.01.1400** Connecting Rod

OEM	OE



**670.01.1500** Crankshaft

OEM	OE



**670.01.1502** Screw for Crankshaft

OEM	OE



**671.01.1600** Bearing Cover

OEM	OE



**122.01.1700** Piston With Rings (STD)

OEM	OE
SEB22530	21136690
K006026	7421136690
K012079	51541196008
	51541196009

122.01.1700-Ø92.00 mm  
122.01.1710-Ø92.25 mm  
122.01.1720-Ø92.50 mm  
122.01.1730-Ø92.75 mm  
122.01.1740-Ø93.00 mm



**122.01.1800** Piston Ring Kit (STD)

OEM	OE

122.01.1800-Ø92.00 mm  
122.01.1810-Ø92.25 mm  
122.01.1820-Ø92.50 mm  
122.01.1830-Ø92.75 mm  
122.01.1840-Ø93.00 mm



**670.01.2300** Repair Kit With Bushing

	OEM	OE

**670.01.2350** Repair Kit w/o Bushing

	OEM	OE

**670.01.2330** Repair Kit

	OEM	OE

**670.01.2320** Repair Kit

	OEM	OE

**670.01.1280** Head Repair Kit

	OEM	OE

**670.01.2100** Gasket & Sealing Kit

	OEM	OE

**265.01.2200** Valve Kit

	OEM	OE

**670.01.2500** Unloader Valve Kit

	OEM	OE
	K034874K50	

**671.01.1920** Lubrication Hose

	OEM	OE

**671.01.2900** Gear

	OEM	OE

**235.01.1103** Bearing

	OEM	OE

**130.01.2700** Screw Kit

	OEM	OE

**670.01.2600** Bushing

	OEM	OE
	5010767	5010767

**671.01.1900** Bottom Cover Kit

	OEM	OE

	OEM	OE

	OEM	OE

	OEM	OE

	OEM	OE

674.01.1000

Compressor (Single Cylinder)

Application: CATERPILLAR ENGINE Truck 3116 C7 C9 - Petroleum Products TH31-C9

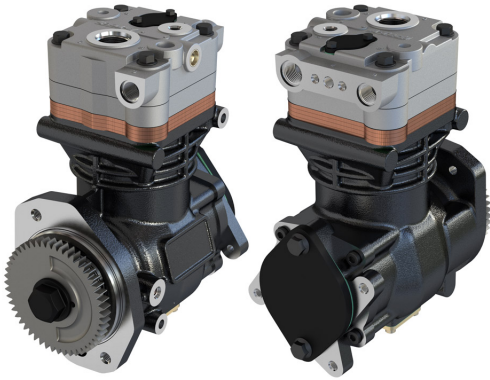

OEM	OE
BA-921	K066810
5010806	K066829
5010803	K066830
5010804	K066836
5010805	K068004
5015207	801285
5015208	801955
5016858	K209337
5016859	
5016895	
K048932	
K048933	
K048934	
K048935	
K048936	
K048937	
K066809	

Cylinder Bore	Ø92
Stroke	54
Swept Volume	360
Air Inlet Port Size	1 3/16-12 UN
Air Delivery Port Size	7/8'-14UNF-2B
Number of Cylinders	1
Through Drive	Yes
Unloader Port Size	1/8" 27 NPT
Water Or Air Cooled	W
Water Inlet Port Size	3/4'-16 UNF-2B
Water Delivery Port Size	3/4'-16 UNF-2B
Water Cooled Valve Plate	Yes

Components

674.01.1100 Crankcase

OEM	OE

674.01.1200 Cylinder Head

OEM	OE

674.01.1220 Cylinder Upper Head

OEM	OE

670.01.1230 Cylinder Lower Head

OEM	OE
	SEB01728004 42471272

674.01.1210 Cylinder Head With Plate Kit

OEM	OE

670.01.1400 Connecting Rod

OEM	OE

670.01.1470 Connecting Rod & Piston Rep Kit

OEM	OE

674.01.1500 Crankshaft

OEM	OE

670.01.1502 Screw for Crankshaft

OEM	OE

674.01.1510 Pump Adapter

OEM	OE

122.01.1700 Piston With Rings (STD)

OEM	OE
	SEB22530 21136690 K006026 7421136690 K012079 51541196008 51541196009
122.01.1700-Ø92.00 mm	
122.01.1710-Ø92.25 mm	
122.01.1720-Ø92.50 mm	
122.01.1730-Ø92.75 mm	
122.01.1740-Ø93.00 mm	

122.01.1800 Piston Ring Kit (STD)

OEM	OE
122.01.1800-Ø92.00 mm	
122.01.1810-Ø92.25 mm	
122.01.1820-Ø92.50 mm	
122.01.1830-Ø92.75 mm	
122.01.1840-Ø93.00 mm	

670.01.2300 Repair Kit With Bushing		OEM	OE

670.01.2350 Repair Kit w/o Bushing		OEM	OE

670.01.2330 Repair Kit		OEM	OE

670.01.2320 Repair Kit		OEM	OE

670.01.1280 Head Repair Kit		OEM	OE

670.01.2100 Gasket & Sealing Kit		OEM	OE

265.01.2200 Valve Kit		OEM	OE

670.01.2500 Unloader Valve Kit		OEM	OE
		K034874K50	

670.01.1300 Plate Kit		OEM	OE

670.01.1310 Plate Kit, Complete		OEM	OE

670.01.1600 Bearing Cover		OEM	OE

670.01.1640 Cover Kit		OEM	OE

120.01.1900 Bottom Cover Kit		OEM	OE

670.01.2600 Bushing		OEM	OE
		5010767	5010767

674.01.2900 Gear		OEM	OE

235.01.1103 Bearing		OEM	OE

130.01.2700 Screw Kit		OEM	OE

		OEM	OE



735.01.1000

Compressor (Twin Cylinder)

Application: 298 cc



OEM	OE
Tu-Flo550	185-5140
5005790	167-1288
800594	
5005606	
5005770	
5005791	
5007465	
5007466	
5007467	
800724	
K046145	

Cylinder Bore	Ø70,61
Stroke	19
Swept Volume	297.6
Air Inlet Port Size	-
Air Delivery Port Size	-
Number of Cylinders	2
Through Drive	Yes
Unloader Port Size	1/8'-27 NPT
Water Or Air Cooled	W
Water Inlet Port Size	1/2'-14 NPT
Water Delivery Port Size	1/2'-14 NPT
Water Cooled Valve Plate	Yes

Components

**759.01.1100 Crankcase**

OEM	OE



**712.01.1200 Cylinder Head**

OEM	OE
107082	9P920283



**712.01.1400 Connecting Rod**

OEM	OE
108841	



**712.01.1410 Big end Bearing**

OEM	OE
107651	



**712.01.1470 Connecting Rod & Piston Rep**

OEM	OE
108843	



**759.01.1500 Crankshaft**

OEM	OE



**636.01.1580 Nut For Crankshaft**

OEM	OE



**735.01.1600 Bearing Cover**

OEM	OE



**712.01.1700 Piston With Rings (STD)**

OEM	OE



712.01.1700-Ø70.64 mm  
712.01.1710-Ø70.89 mm  
712.01.1720-Ø71.14 mm  
712.01.1730-Ø71.39 mm  
712.01.1740-Ø71.64 mm

**712.01.1701 Piston (STD)**

OEM	OE
107647	



712.01.1701-Ø70.64 mm  
712.01.1711-Ø70.89 mm  
712.01.1721-Ø71.14 mm  
712.01.1731-Ø71.39 mm  
712.01.1741-Ø71.64 mm

**712.01.1800 Piston Ring Kit (STD)**

OEM	OE
5005361 107639	



712.01.1800-Ø70.64 mm  
712.01.1810-Ø70.89 mm  
712.01.1820-Ø71.14 mm  
712.01.1830-Ø71.39 mm  
712.01.1840-Ø71.64 mm

**735.01.2600 Bushing**

OEM	OE

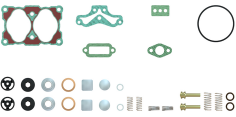

672.01.2600 Bushing	
OEM	OE
	AK2500350R

712.01.2350 Repair Kit w/o Bushing	
OEM	OE
	107516
	107516 2K200296

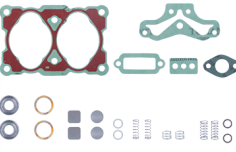
712.01.2320 Repair Kit	
OEM	OE
	

712.01.2100 Gasket & Sealing Kit	
OEM	OE
	

712.01.2200 Valve Kit	
OEM	OE
	

OEM	OE

OEM	OE

OEM	OE

OEM	OE

OEM	OE

OEM	OE

OEM	OE

OEM	OE

OEM	OE

OEM	OE

OEM	OE

OEM	OE

OEM	OE

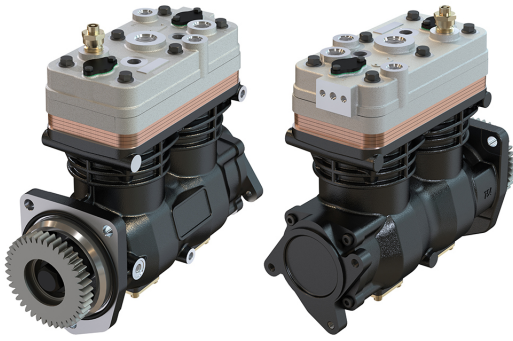

OEM	OE
BA-922	226-9579
5011624	304-2694
5013063	10R2767
5013064	20R-0179
5020479	10R-6316
801594	257-9346
5013058	
K048564	
K048565	
K048566	
K023904	
K023905	

<b>Cylinder Bore</b>	Ø92
<b>Stroke</b>	54
<b>Swept Volume</b>	720
<b>Air Inlet Port Size</b>	1 3/16" 12UN -2B
<b>Air Delivery Port Size</b>	7/8" 14UNF -2B
<b>Number of Cylinders</b>	2
<b>Through Drive</b>	Yes
<b>Unloader Port Size</b>	1/8" 27 NPT
<b>Water Or Air Cooled</b>	W
<b>Water Inlet Port Size</b>	3/4" 16UNF -2B
<b>Water Delivery Port Size</b>	3/4" 16UNF -2B
<b>Water Cooled Valve Plate</b>	Yes

## Components

754.01.1100 Crankcase

	OEM	OE

675.01.1200 Cylinder Head

	OEM	OE

675.01.1220 Cylinder Upper Head

	OEM	OE

176.01.1230 Cylinder Lower Head

	OEM	OE

675.01.1210 Cylinder Head With Plate Kit

	OEM	OE
	K033300	

176.01.1300 Plate Kit

	OEM	OE

670.01.1400 Connecting Rod

	OEM	OE

754.01.1500 Crankshaft

	OEM	OE

122.01.1700 Piston With Rings (STD)

	OEM	OE
	SEB22530 K006026 K012079	21136690 7421136690 51541196008 51541196009
122.01.1700-Ø92.00 mm 122.01.1710-Ø92.25 mm 122.01.1720-Ø92.50 mm 122.01.1730-Ø92.75 mm 122.01.1740-Ø93.00 mm		

122.01.1800 Piston Ring Kit (STD)

	OEM	OE
122.01.1800-Ø92.00 mm 122.01.1810-Ø92.25 mm 122.01.1820-Ø92.50 mm 122.01.1830-Ø92.75 mm 122.01.1840-Ø93.00 mm		

175.01.1900 Bottom Cover Kit

	OEM	OE

670.01.2600 Bushing

	OEM	OE
	5010767	5010767

110.01.2700 Screw Kit		OEM	OE

176.01.2300 Repair Kit With Bushing		OEM	OE

176.01.2350 Repair Kit w/o Bushing		OEM	OE

176.01.2330 Repair Kit		OEM	OE

176.01.2320 Repair Kit		OEM	OE

176.01.1280 Head Repair Kit		OEM	OE

176.01.2100 Gasket & Sealing Kit		OEM	OE

176.01.2200 Valve Kit		OEM	OE

175.01.2500 Unloader Valve Kit		OEM	OE
		K034874K50 K159064K50 K049446	1919356 0021304915

671.01.1600 Bearing Cover		OEM	OE

671.01.2900 Gear		OEM	OE

235.01.1103 Bearing		OEM	OE

		OEM	OE

		OEM	OE

		OEM	OE

		OEM	OE

		OEM	OE

		OEM	OE

755.01.1000

Compressor (Twin Cylinder)

Application: Truck C15 Petroleum Products CX31C15I CX31P600 TH35C15I TH35C15I

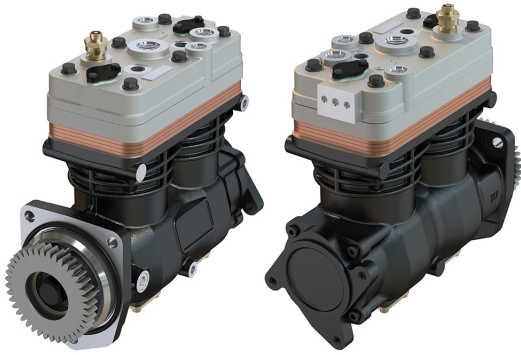

OEM	OE
BA-922	440-1616
5011625	304-2693
5013070	10R2768
5013071	10R-6317
5013059	20R-0180
5013071	226-9580
5020482	
801595	
K023907	
K048569	
K048567	
K048568	
K098559	
K098560	
K209339	
K023906	

Cylinder Bore	Ø92
Stroke	54
Swept Volume	720
Air Inlet Port Size	1 3/16" 12UN -2B
Air Delivery Port Size	7/8" 14UNF -2B
Number of Cylinders	2
Through Drive	Yes
Unloader Port Size	1/8" 27 NPT
Water Or Air Cooled	W
Water Inlet Port Size	3/4" 16UNF -2B
Water Delivery Port Size	3/4" 16UNF -2B
Water Cooled Valve Plate	Yes

Components

754.01.1100 Crankcase

	OEM	OE

675.01.1200 Cylinder Head

	OEM	OE

675.01.1220 Cylinder Upper Head

	OEM	OE

176.01.1230 Cylinder Lower Head

	OEM	OE

675.01.1210 Cylinder Head With Plate Kit

	OEM	OE
	K033300	

176.01.1300 Plate Kit

	OEM	OE

670.01.1400 Connecting Rod

	OEM	OE

754.01.1500 Crankshaft

	OEM	OE

122.01.1700 Piston With Rings (STD)

	OEM	OE
	SEB22530	21136690
	K006026	7421136690
	K012079	51541196008
		51541196009
	122.01.1700-Ø92.00 mm	
	122.01.1710-Ø92.25 mm	
	122.01.1720-Ø92.50 mm	
	122.01.1730-Ø92.75 mm	
	122.01.1740-Ø93.00 mm	

122.01.1800 Piston Ring Kit (STD)

	OEM	OE
	122.01.1800-Ø92.00 mm	
	122.01.1810-Ø92.25 mm	
	122.01.1820-Ø92.50 mm	
	122.01.1830-Ø92.75 mm	
	122.01.1840-Ø93.00 mm	

175.01.1900 Bottom Cover Kit

	OEM	OE

670.01.2600 Bushing

	OEM	OE
	5010767	5010767

110.01.2700 Screw Kit		
	OEM	OE

176.01.2300 Repair Kit With Bushing		
	OEM	OE

176.01.2350 Repair Kit w/o Bushing		
	OEM	OE

176.01.2330 Repair Kit		
	OEM	OE

176.01.2320 Repair Kit		
	OEM	OE

176.01.1280 Head Repair Kit		
	OEM	OE

176.01.2100 Gasket & Sealing Kit		
	OEM	OE

176.01.2200 Valve Kit		
	OEM	OE

175.01.2500 Unloader Valve Kit		
	OEM	OE
	K034874K50 K159064K50 K049446	1919356 0021304915

671.01.1600 Bearing Cover		
	OEM	OE

670.01.2900 Gear		
	OEM	OE
		F5733X0

235.01.1103 Bearing		
	OEM	OE

	OEM	OE

	OEM	OE

	OEM	OE

	OEM	OE

	OEM	OE

	OEM	OE

759.01.1000

Compressor (Twin Cylinder)

Application: CATERPILLAR ENGINE Earthmoving Compactor 825C 826C - Motor Grade

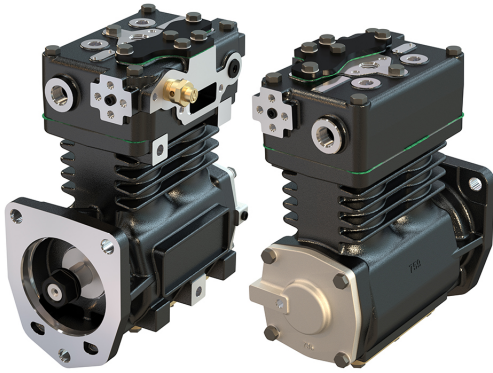

OEM	OE
Tu-Flo550	108990
5003230	800292
5003229	65684
5003228	65465
5002984	65424
5002032	215-8055
5001774	0R-3845
5001773	0R-8340
5001523	1316679
5001522	745X5002984
109861	102-9551
109860	
109816	
109321	
109319	
109139	
109138	

Cylinder Bore	Ø70,64
Stroke	38
Swept Volume	298
Air Inlet Port Size	-
Air Delivery Port Size	1/2'-14 NPTF
Number of Cylinders	2
Through Drive	Yes
Unloader Port Size	1/8'- 27 NPTF
Water Or Air Cooled	W
Water Inlet Port Size	1/2'-14 NPTF
Water Delivery Port Size	1/2'-14 NPTF
Water Cooled Valve Plate	Yes

Components

759.01.1100 Crankcase

OEM	OE

712.01.1200 Cylinder Head

OEM	OE
107082	9P920283

712.01.1400 Connecting Rod

OEM	OE
108841	

712.01.1410 Big end Bearing

OEM	OE
107651	

712.01.1470 Connecting Rod & Piston Rep

OEM	OE
108843	

759.01.1500 Crankshaft

OEM	OE

636.01.1580 Nut For Crankshaft

OEM	OE

759.01.1600 Bearing Cover

OEM	OE

712.01.1700 Piston With Rings (STD)

OEM	OE

712.01.1700-Ø70.64 mm  
712.01.1710-Ø70.89 mm  
712.01.1720-Ø71.14 mm  
712.01.1730-Ø71.39 mm  
712.01.1740-Ø71.64 mm

712.01.1701 Piston (STD)

OEM	OE
107647	

712.01.1701-Ø70.64 mm  
712.01.1711-Ø70.89 mm  
712.01.1721-Ø71.14 mm  
712.01.1731-Ø71.39 mm  
712.01.1741-Ø71.64 mm

712.01.1800 Piston Ring Kit (STD)

OEM	OE
5005361 107639	

712.01.1800-Ø70.64 mm  
712.01.1810-Ø70.89 mm  
712.01.1820-Ø71.14 mm  
712.01.1830-Ø71.39 mm  
712.01.1840-Ø71.64 mm

712.01.2350 Repair Kit w/o Bushing

OEM	OE
107516	107516 2K200296

712.01.2320 Repair Kit		OEM	OE

712.01.2100 Gasket & Sealing Kit		OEM	OE

712.01.2200 Valve Kit		OEM	OE

735.01.2600 Bushing		OEM	OE

672.01.2600 Bushing		OEM	OE
			AK2500350R

		OEM	OE

		OEM	OE

		OEM	OE

		OEM	OE

		OEM	OE

		OEM	OE

		OEM	OE

		OEM	OE

		OEM	OE

		OEM	OE

		OEM	OE

		OEM	OE

		OEM	OE



825.01.1000

Compressor (Twin Cylinder)

Application: CATERPILLAR ENGINE 120H / 120H / ES 120H NA / 135H / 135H NA

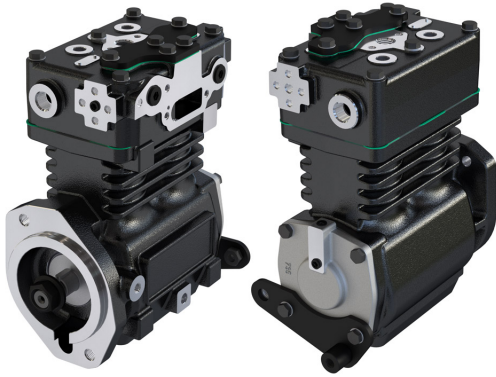

OEM	OE
Tu-Flo550	145-0840
5003179	
5003302	
5003323	
5003324	
800328	

Cylinder Bore	Ø70,64
Stroke	38
Swept Volume	298
Air Inlet Port Size	-
Air Delivery Port Size	1/2'-14 NPTF
Number of Cylinders	2
Through Drive	Yes
Unloader Port Size	1/8'- 27 NPTF
Water Or Air Cooled	W
Water Inlet Port Size	1/2'-14 NPTF
Water Delivery Port Size	1/2'-14 NPTF
Water Cooled Valve Plate	Yes

Components

825.01.1100 Crankcase

OEM	OE

712.01.1200 Cylinder Head

OEM	OE
107082	9P920283

712.01.1400 Connecting Rod

OEM	OE
108841	

712.01.1410 Big end Bearing

OEM	OE
107651	

825.01.1500 Crankshaft

OEM	OE

712.01.1510 Pump Adapter

OEM	OE

802.01.1580 Nut For Crankshaft

OEM	OE

735.01.1600 Bearing Cover

OEM	OE

712.01.1700 Piston With Rings (STD)

OEM	OE
712.01.1700-Ø70.64 mm 712.01.1710-Ø70.89 mm 712.01.1720-Ø71.14 mm 712.01.1730-Ø71.39 mm 712.01.1740-Ø71.64 mm	

712.01.1701 Piston (STD)

OEM	OE
107647	

712.01.1701-Ø70.64 mm  
712.01.1711-Ø70.89 mm  
712.01.1721-Ø71.14 mm  
712.01.1731-Ø71.39 mm  
712.01.1741-Ø71.64 mm

712.01.1800 Piston Ring Kit (STD)

OEM	OE
5005361 107639	

712.01.1800-Ø70.64 mm  
712.01.1810-Ø70.89 mm  
712.01.1820-Ø71.14 mm  
712.01.1830-Ø71.39 mm  
712.01.1840-Ø71.64 mm

697.01.1900 Bottom Cover Kit

OEM	OE

**672.01.2600** Bushing

OEM	OE
	AK2500350R



**697.01.2700** Screw Kit

OEM	OE



**825.01.3300** Pump Support

OEM	OE



**712.01.2350** Repair Kit w/o Bushing

OEM	OE
107516	107516 2K200296

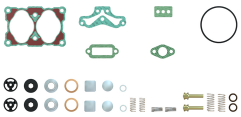

**712.01.2320** Repair Kit

OEM	OE



**712.01.2100** Gasket & Sealing Kit

OEM	OE



**712.01.2200** Valve Kit

OEM	OE



OEM	OE

OEM	OE

OEM	OE

OEM	OE

OEM	OE

OEM	OE

OEM	OE

OEM	OE

OEM	OE

OEM	OE

OEM	OE

830.01.1000

Compressor (Twin Cylinder)

Application: CATER PILLAR ENGINE 3406 / C10 / C12 / C15/ C16

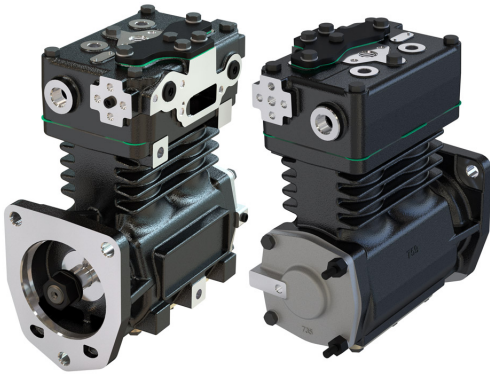

OEM	OE
Tu-Flo750	132-9814
5001788	164-7564
5001789	0R-4740
5002033	0R-8253
5002652	0R-8341
5002713	118-2806
5003234	
5003235	
5003236	
5005419	
5005478	
5005479	
800256	
65683	
109863	
109824	
K061564	

<b>Cylinder Bore</b>	Ø70,61
<b>Stroke</b>	24
<b>Swept Volume</b>	375.92
<b>Air Inlet Port Size</b>	-
<b>Air Delivery Port Size</b>	-
<b>Number of Cylinders</b>	2
<b>Through Drive</b>	Yes
<b>Unloader Port Size</b>	1/8'-27 NPT
<b>Water Or Air Cooled</b>	W
<b>Water Inlet Port Size</b>	1/2'-14 NPT
<b>Water Delivery Port Size</b>	1/2'-14 NPT
<b>Water Cooled Valve Plate</b>	Yes

Components

759.01.1100 Crankcase

OEM	OE

712.01.1200 Cylinder Head

OEM	OE
107082	9P920283

712.01.1400 Connecting Rod

OEM	OE
108841	

712.01.1410 Big end Bearing

OEM	OE
107651	

712.01.1470 Connecting Rod & Piston Rep

OEM	OE
108843	

8324.01.1500 Crankshaft

OEM	OE

636.01.1580 Nut For Crankshaft

OEM	OE

759.01.1600 Bearing Cover

OEM	OE

697.01.1700 Piston With Rings (STD)

OEM	OE
697.01.1700-Ø70.64 mm	
697.01.1710-Ø70.89 mm	
697.01.1720-Ø71.14 mm	
697.01.1730-Ø71.39 mm	
697.01.1740-Ø71.64 mm	

697.01.1701 Piston Ring Kit (STD)

OEM	OE
697.01.1701-Ø70.64 mm	
697.01.1711-Ø70.89 mm	
697.01.1721-Ø71.14 mm	
697.01.1731-Ø71.39 mm	
697.01.1741-Ø71.64 mm	

712.01.1800 Piston Ring Kit (STD)

OEM	OE
5005361	
107639	
712.01.1800-Ø70.64 mm	
712.01.1810-Ø70.89 mm	
712.01.1820-Ø71.14 mm	
712.01.1830-Ø71.39 mm	
712.01.1840-Ø71.64 mm	

735.01.2600 Bushing

OEM	OE

672.01.2600 Bushing	
OEM	OE
	AK2500350R

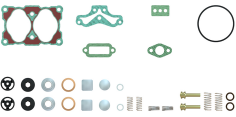
712.01.2350 Repair Kit w/o Bushing	
OEM	OE
	107516
	107516 2K200296

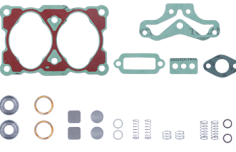
712.01.2320 Repair Kit	
OEM	OE
	

712.01.2100 Gasket & Sealing Kit	
OEM	OE
	

712.01.2200 Valve Kit	
OEM	OE
	

OEM	OE

OEM	OE

OEM	OE

OEM	OE

OEM	OE

OEM	OE

OEM	OE

OEM	OE

OEM	OE

OEM	OE

OEM	OE

OEM	OE

OEM	OE

Application: CATER PILLAR ENGINE 3176 / C15/C16

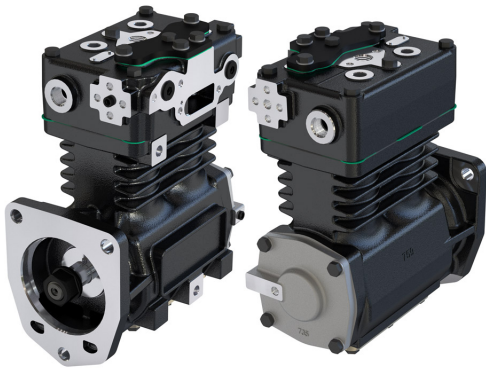

OEM	OE
Tu-Flo750	5007470
5001533	5007471
5001534	65466
5002082	109141
5002826	109142
5002983	109322
5003231	800291
5003232	800725
5003233	65426
5005421	108992
5005422	K046146
5005491	
5005492	
5005496	
5007468	
5007468	
5007469	

Cylinder Bore	Ø70,61
Stroke	24
Swept Volume	375.92
Air Inlet Port Size	-
Air Delivery Port Size	-
Number of Cylinders	2
Through Drive	Yes
Unloader Port Size	1/8'-27 NPT
Water Or Air Cooled	W
Water Inlet Port Size	1/2'-14 NPT
Water Delivery Port Size	1/2'-14 NPT
Water Cooled Valve Plate	Yes

## Components

759.01.1100 Crankcase



OEM	OE

712.01.1200 Cylinder Head

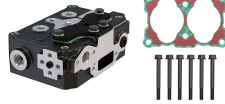

OEM	OE
107082	9P920283

712.01.1400 Connecting Rod



OEM	OE
108841	

712.01.1410 Big end Bearing



OEM	OE
107651	

712.01.1470 Connecting Rod & Piston Rep



OEM	OE
108843	

6824.01.1500 Crankshaft



OEM	OE

636.01.1580 Nut For Crankshaft



OEM	OE

735.01.1600 Bearing Cover



OEM	OE

697.01.1700 Piston With Rings (STD)



OEM	OE

697.01.1700-Ø70.64 mm  
697.01.1710-Ø70.89 mm  
697.01.1720-Ø71.14 mm  
697.01.1730-Ø71.39 mm  
697.01.1740-Ø71.64 mm

697.01.1701 Piston Ring Kit (STD)



OEM	OE

697.01.1701-Ø70.64 mm  
697.01.1711-Ø70.89 mm  
697.01.1721-Ø71.14 mm  
697.01.1731-Ø71.39 mm  
697.01.1741-Ø71.64 mm

712.01.1800 Piston Ring Kit (STD)



OEM	OE
5005361	107639

712.01.1800-Ø70.64 mm  
712.01.1810-Ø70.89 mm  
712.01.1820-Ø71.14 mm  
712.01.1830-Ø71.39 mm  
712.01.1840-Ø71.64 mm

735.01.2600 Bushing

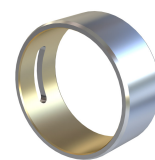

OEM	OE

672.01.2600 Bushing	
OEM	OE
	AK2500350R

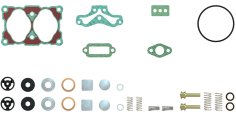
712.01.2350 Repair Kit w/o Bushing	
OEM	OE
	107516
	107516 2K200296

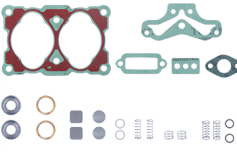
712.01.2320 Repair Kit	
OEM	OE
	

712.01.2100 Gasket & Sealing Kit	
OEM	OE
	

712.01.2200 Valve Kit	
OEM	OE
	

OEM	OE

OEM	OE

OEM	OE

OEM	OE

OEM	OE

OEM	OE

OEM	OE

OEM	OE

OEM	OE

OEM	OE

OEM	OE

OEM	OE

OEM	OE