

174.01.1000

Compressor (Twin Cylinder)

Application: OTOKAR KENT B7R

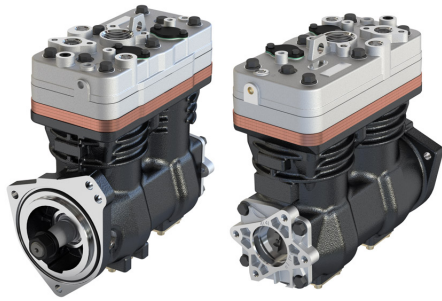

OEM	OE
LK4954	21040143
K017528	21101027
	04905533

Cylinder Bore	Ø92
Stroke	54 mm
Swept Volume	720 cc
Air Inlet Port Size	M26*1,5
Air Delivery Port Size	M26*1,5
Number of Cylinders	2
Through Drive	YES
Unloader Port Size	M10*1,5
Water Or Air Cooled	W
Water Inlet Port Size	M16*1,5
Water Delivery Port Size	M16*1,5
Water Cooled Valve Plate	YES

Components

174.01.1100 Crankcase

	OEM	OE

174.01.1200 Cylinder Head

	OEM	OE

174.01.1220 Cylinder Upper Head

	OEM	OE
	K017529	7421136561

175.01.1230 Cylinder Lower Head

	OEM	OE

174.01.1210 Cylinder Head With Plate Kit

	OEM	OE
		21136561

186.06.100 Safety valve

	OEM	OE
	K015499	

175.01.1300 Plate Kit

	OEM	OE
	K012074	21136726

172.01.1400 Connecting Rod

	OEM	OE

174.01.1500 Crankshaft

	OEM	OE

174.01.1600 Bearing Cover

	OEM	OE

122.01.1700 Piston With Rings (STD)

	OEM	OE
	SEB22530	21136690
	K006026	7421136690
	K012079	51541196008
		51541196009
122.01.1700-Ø92.00 mm		
122.01.1710-Ø92.25 mm		
122.01.1720-Ø92.50 mm		
122.01.1730-Ø92.75 mm		
122.01.1740-Ø93.00 mm		

122.01.1800 Piston Ring Kit (STD)

	OEM	OE
122.01.1800-Ø92.00 mm		
122.01.1810-Ø92.25 mm		
122.01.1820-Ø92.50 mm		
122.01.1830-Ø92.75 mm		
122.01.1840-Ø93.00 mm		

174.01.2300 Repair Kit With Bushing

	OEM	OE

174.01.2350 Repair Kit w/o Bushing

	OEM	OE
	K012086	7421136724

174.01.2330 Repair Kit

	OEM	OE

174.01.2320 Repair Kit

	OEM	OE

175.01.1280 Head Repair Kit

	OEM	OE

174.01.2100 Gasket & Sealing Kit

	OEM	OE

175.01.2200 Valve Kit

	OEM	OE
		1322813

175.01.2500 Unloader Valve Kit

	OEM	OE
	K034874K50 K159064K50 K049446	1919356 0021304915

102.01.2600 Bushing

	OEM	OE
	EB00819	1315274 1697278 1697286 5001830853 1697286

175.01.1900 Bottom Cover Kit

	OEM	OE

110.01.2700 Screw Kit

	OEM	OE

102.01.1580 Nut For Crankshaft

	OEM	OE
		464642 1315273 1698672 1698672 464642

174.01.2900 Gear

	OEM	OE

	OEM	OE

	OEM	OE

	OEM	OE

	OEM	OE

	OEM	OE

186.01.1000

Compressor (Twin Cylinder)

Application: PREMIUM DX17 / MIDLUM DXI5-7 / PT PINDAD - OTOKAR KENT

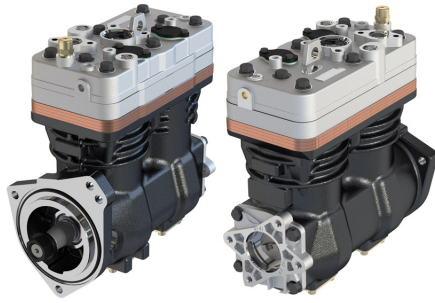

OEM	OE
LK4944	7485003045
K017527000	04905532
K017527X00	21098919
	16N10-16708-AA
	7421098922

Cylinder Bore	Ø92
Stroke	54 mm
Swept Volume	720 cc
Air Inlet Port Size	M26x1.5
Air Delivery Port Size	M26x1.5
Number of Cylinders	2
Through Drive	Yes
Unloader Port Size	M10x1
Water Or Air Cooled	W
Water Inlet Port Size	M16x1.5
Water Delivery Port Size	M16x1.5
Water Cooled Valve Plate	Yes

Components

174.01.1100 Crankcase



OEM	OE

174.01.1200 Cylinder Head



OEM	OE

174.01.1220 Cylinder Upper Head



OEM	OE
K017529	7421136561

175.01.1230 Cylinder Lower Head



OEM	OE

174.01.1210 Cylinder Head With Plate Kit



OEM	OE
	21136561

175.01.1300 Plate Kit

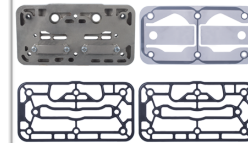

OEM	OE
K012074	21136726

172.01.1400 Connecting Rod



OEM	OE

174.01.1500 Crankshaft



OEM	OE

174.01.1600 Bearing Cover



OEM	OE

102.01.2600 Bushing



OEM	OE
EB00819	1315274
	1697278
	1697286
	5001830853
	1697286

122.01.1700 Piston With Rings (STD)



OEM	OE
SEB22530	21136690
K006026	7421136690
K012079	51541196008
	51541196009

122.01.1700-Ø92.00 mm
 122.01.1710-Ø92.25 mm
 122.01.1720-Ø92.50 mm
 122.01.1730-Ø92.75 mm
 122.01.1740-Ø93.00 mm

122.01.1800 Piston Ring Kit (STD)



OEM	OE

122.01.1800-Ø92.00 mm
 122.01.1810-Ø92.25 mm
 122.01.1820-Ø92.50 mm
 122.01.1830-Ø92.75 mm
 122.01.1840-Ø93.00 mm

174.01.2300 Repair Kit With Bushing

	OEM	OE

174.01.2350 Repair Kit w/o Bushing

	OEM	OE
	K012086	7421136724

174.01.2330 Repair Kit

	OEM	OE

174.01.2320 Repair Kit

	OEM	OE

175.01.1280 Head Repair Kit

	OEM	OE

174.01.2100 Gasket & Sealing Kit

	OEM	OE

175.01.2200 Valve Kit

	OEM	OE
		1322813

175.01.2500 Unloader Valve Kit

	OEM	OE
	K034874K50 K159064K50 K049446	1919356 0021304915

175.01.1900 Bottom Cover Kit

	OEM	OE

110.01.2700 Screw Kit

	OEM	OE

	OEM	OE

	OEM	OE

	OEM	OE

	OEM	OE

	OEM	OE

	OEM	OE

	OEM	OE

	OEM	OE

297.01.1000

Compressor (Twin Cylinder)

Application: 600 cc

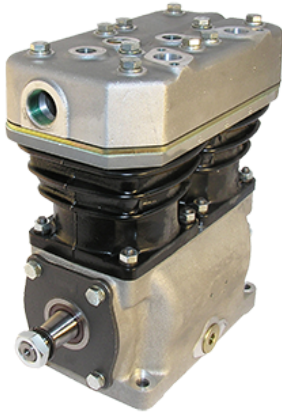

OEM	OE
LP4924 I87734	01177094

Cylinder Bore	Ø88
Stroke	50 mm
Swept Volume	600 cc
Air Inlet Port Size	Ø20
Air Delivery Port Size	M26*1,5
Number of Cylinders	2
Through Drive	Yes
Unloader Port Size	-
Water Or Air Cooled	W
Water Inlet Port Size	M14x1.5
Water Delivery Port Size	M14x1.5
Water Cooled Valve Plate	Yes

Components

297.01.1100 Crankcase		
	OEM	OE

297.01.1200 Cylinder Head		
	OEM	OE

297.01.1210 Cylinder Head With Plate Kit		
	OEM	OE

269.01.1300 Plate Kit		
	OEM	OE
	II17974004	81541246029

297.01.1400 Connecting Rod		
	OEM	OE

297.01.1500 Crankshaft		
	OEM	OE

297.01.1600 Bearing Cover		
	OEM	OE

269.01.2800 Cylinder Liner		
	OEM	OE

269.01.2810 Cylinder Liner Kit		
	OEM	OE
	II40277F0061	51541196003

297.01.2600 Bushing		
	OEM	OE

110.01.1700 Piston With Rings (STD)		
	OEM	OE
	SEB22555 I81169004	1361265 1409318 1698848 3095841 51541036001 81541190007 85101375
110.01.1700-Ø88.00 mm 110.01.1710-Ø88.25 mm 110.01.1720-Ø88.50 mm 110.01.1730-Ø88.75 mm 110.01.1740-Ø89.00 mm		

110.01.1800 Piston Ring Kit (STD)		
	OEM	OE
	I811690062 II39526F0061	3097153 85100626
110.01.1800-Ø88.00 mm 110.01.1810-Ø88.25 mm 110.01.1820-Ø88.50 mm 110.01.1830-Ø88.75 mm 110.01.1840-Ø89.00 mm		

297.01.2300 Repair Kit With Bushing

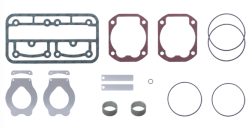
	OEM	OE
		

297.01.2350 Repair Kit w/o Bushing

	OEM	OE
		

297.01.2320 Repair Kit

	OEM	OE
		

297.01.1280 Head Repair Kit

	OEM	OE
		

297.01.2100 Gasket & Sealing Kit

	OEM	OE
		

297.01.2200 Valve Kit

	OEM	OE
		

269.01.2700 Screw Kit

	OEM	OE
		

	OEM	OE

	OEM	OE

	OEM	OE

	OEM	OE

	OEM	OE

	OEM	OE

	OEM	OE

	OEM	OE

	OEM	OE

	OEM	OE

	OEM	OE

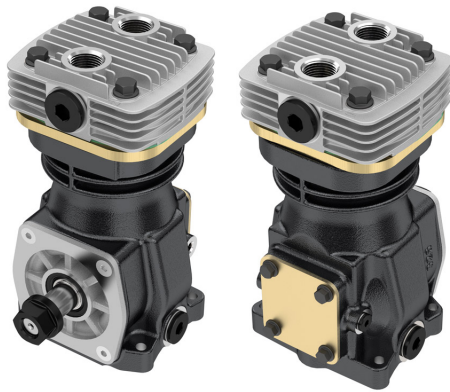
326.01.1000
Compressor (Single Cylinder)
Application: 159 cc

OEM	OE
4111410000	82003029 1517932 01173877 04415517 AL68237

Cylinder Bore	Ø75
Stroke	36 mm
Swept Volume	159 cc
Air Inlet Port Size	M26*1,5
Air Delivery Port Size	M26*1,5
Number of Cylinders	1
Through Drive	YES
Unloader Port Size	-
Water Or Air Cooled	A
Water Inlet Port Size	-
Water Delivery Port Size	-
Water Cooled Valve Plate	NO

Components

326.01.1100 Crankcase

	OEM	OE
		

326.01.1200 Cylinder Head

	OEM	OE
	4111416504	

326.01.1210 Cylinder Head With Plate Kit

	OEM	OE
	4111419262	

326.01.1300 Plate Kit

	OEM	OE
	4111415012	0001304920

326.01.1400 Connecting Rod

	OEM	OE
	4111417322	0001311517

326.01.1500 Crankshaft

	OEM	OE
	4111416904 4111416904 4111436904	0001313916

326.01.1600 Bearing Cover

	OEM	OE
	4111406622 4111419232	0001312432

326.01.1610 Bearing Cover

	OEM	OE
		

326.01.2200 Valve Kit

	OEM	OE
		

326.01.2600 Bushing

	OEM	OE
	4110423404	

218.01.1700 Piston With Rings (STD)

	OEM	OE
	4111416232	513860 8121570 9982648 5000816053 0001311607 81541190004 81541196039
218.01.1700-Ø75.00 mm		
218.01.1710-Ø75.25 mm		
218.01.1720-Ø75.50 mm		
218.01.1730-Ø75.75 mm		
218.01.1740-Ø76.00 mm		

102.01.1800 Piston Ring Kit (STD)

	OEM	OE
	4111416232 1801770061 8956710204 4111419202	513839 513843 1283826 1391384 1391385 1396835 3090388 0011310711
102.01.1800-Ø75.00 mm		
102.01.1810-Ø75.25 mm		
102.01.1820-Ø75.50 mm		
102.01.1830-Ø75.75 mm		
102.01.1840-Ø76.00 mm		

326.01.2300 Repair Kit With Bushing		
	OEM	OE
		

326.01.2350 Repair Kit w/o Bushing		
	OEM	OE
		

326.01.1280 Head Repair Kit		
	OEM	OE
		

326.01.2100 Gasket & Sealing Kit		
	OEM	OE
		

130.01.2600 Bushing		
	OEM	OE
	B44935 B64572	1309548 0001313050 0001313950 81541300009

	OEM	OE

	OEM	OE

	OEM	OE

	OEM	OE

	OEM	OE

	OEM	OE

	OEM	OE

	OEM	OE

	OEM	OE

	OEM	OE

	OEM	OE

	OEM	OE

	OEM	OE

389.01.1000 Compressor (Single Cylinder)

Application: DEUTZ 1013, CARGO 3227

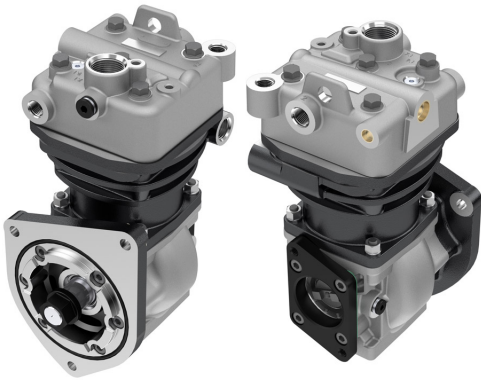

OEM	OE
LK3965	YCT2875AA
K021890	01180656
II33163	

Cylinder Bore	Ø88
Stroke	50 mm
Swept Volume	300 cc
Air Inlet Port Size	M30*1,5
Air Delivery Port Size	M18*1,5
Number of Cylinders	1
Through Drive	YES
Unloader Port Size	M22*1,5
Water Or Air Cooled	W
Water Inlet Port Size	M16*1,5
Water Delivery Port Size	M16*1,5
Water Cooled Valve Plate	YES

Components

389.01.1100 Crankcase		
	OEM	OE
	I80411	

389.01.1200 Cylinder Head		
	OEM	OE

389.01.1210 Cylinder Head With Plate Kit		
	OEM	OE

130.01.1300 Plate Kit		
	OEM	OE
	II14777004	1699825

260.01.1400 Connecting Rod		
	OEM	OE
	I60599	81541060013

389.01.1500 Crankshaft		
	OEM	OE

102.01.1580 Nut For Crankshaft		
	OEM	OE
		464642 1315273 1698672 1698672 464642

389.01.1650 Front Flange		
	OEM	OE

389.01.3300 Pump Support		
	OEM	OE

130.01.2600 Bushing		
	OEM	OE
	B44935 B64572	1309548 0001313050 0001313950 81541300009

110.01.1700 Piston With Rings (STD)		
	OEM	OE
	SEB22555 I81169004	1361265 1409318 1698848 3095841 51541036001 81541190007 85101375
110.01.1700-Ø88.00 mm 110.01.1710-Ø88.25 mm 110.01.1720-Ø88.50 mm 110.01.1730-Ø88.75 mm 110.01.1740-Ø89.00 mm		

110.01.1800 Piston Ring Kit (STD)		
	OEM	OE
	I811690062 II39526F0061	3097153 85100626
110.01.1800-Ø88.00 mm 110.01.1810-Ø88.25 mm 110.01.1820-Ø88.50 mm 110.01.1830-Ø88.75 mm 110.01.1840-Ø89.00 mm		

130.01.2300 Repair Kit With Bushing

OEM	OE

130.01.2350 Repair Kit w/o Bushing

OEM	OE

130.01.2330 Repair Kit

OEM	OE

130.01.2320 Repair Kit

OEM	OE

130.01.1280 Head Repair Kit

OEM	OE

130.01.2100 Gasket & Sealing Kit

OEM	OE
I1147860051 I1186060052	1699822

130.01.2200 Valve Kit

OEM	OE
I1326830061 I186040061	3091592 3091593

130.01.2500 Unloader Valve Kit

OEM	OE
I1159920063	3097147

130.01.2800 Cylinder Liner

OEM	OE
K000998	

130.01.2810 Cylinder Liner Kit

OEM	OE
K000998 I1808640061	

389.01.2900 Gear

OEM	OE

130.01.2700 Screw Kit

OEM	OE

130.01.2610 Bushing

OEM	OE
B44935 B64572	0001313150 81541300007

OEM	OE

OEM	OE

OEM	OE

OEM	OE

OEM	OE

390.01.1000

Compressor (Single Cylinder)

Application: DEUTZ 1013



OEM	OE
LK3966 II32223	01180581

Cylinder Bore	Ø88
Stroke	50 mm
Swept Volume	300 cc
Air Inlet Port Size	M30*1,5
Air Delivery Port Size	M18*1,5
Number of Cylinders	1
Through Drive	YES
Unloader Port Size	M22*1,5
Water Or Air Cooled	W
Water Inlet Port Size	M16*1,5
Water Delivery Port Size	M16*1,5
Water Cooled Valve Plate	YES

Components

389.01.1100 Crankcase



OEM	OE
I180411	

389.01.1200 Cylinder Head



OEM	OE

389.01.1210 Cylinder Head With Plate Kit



OEM	OE

130.01.1300 Plate Kit



OEM	OE
II14777004	1699825

260.01.1400 Connecting Rod



OEM	OE
I60599	81541060013

389.01.1500 Crankshaft

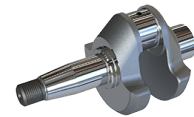

OEM	OE

102.01.1580 Nut For Crankshaft



OEM	OE
	464642 1315273 1698672 1698672 464642

129.01.1600 Bearing Cover



OEM	OE

389.01.1650 Front Flange



OEM	OE

130.01.2600 Bushing



OEM	OE
B44935 B64572	1309548 0001313050 0001313950 81541300009

110.01.1700 Piston With Rings (STD)



110.01.1700-Ø88.00 mm
110.01.1710-Ø88.25 mm
110.01.1720-Ø88.50 mm
110.01.1730-Ø88.75 mm
110.01.1740-Ø89.00 mm

OEM	OE
SEB22555 I81169004	1361265 1409318 1698848 3095841 51541036001 81541190007 85101375

110.01.1800 Piston Ring Kit (STD)



110.01.1800-Ø88.00 mm
110.01.1810-Ø88.25 mm
110.01.1820-Ø88.50 mm
110.01.1830-Ø88.75 mm
110.01.1840-Ø89.00 mm

OEM	OE
I811690062 II39526F0061	3097153 85100626

130.01.2300 Repair Kit With Bushing		OEM	OE

130.01.2350 Repair Kit w/o Bushing		OEM	OE

130.01.2330 Repair Kit		OEM	OE

130.01.2320 Repair Kit		OEM	OE

130.01.1280 Head Repair Kit		OEM	OE

130.01.2100 Gasket & Sealing Kit		OEM	OE
		I1147860051 I1186060052	1699822

130.01.2200 Valve Kit		OEM	OE
		I1326830061 I186040061	3091592 3091593

130.01.2500 Unloader Valve Kit		OEM	OE
		I1159920063	3097147

130.01.2800 Cylinder Liner		OEM	OE
		K000998	

130.01.2810 Cylinder Liner Kit		OEM	OE
		K000998 I1808640061	

130.01.2700 Screw Kit		OEM	OE

130.01.2610 Bushing		OEM	OE
		B44935 B64572	0001313150 81541300007

		OEM	OE

		OEM	OE

		OEM	OE

		OEM	OE

		OEM	OE

		OEM	OE

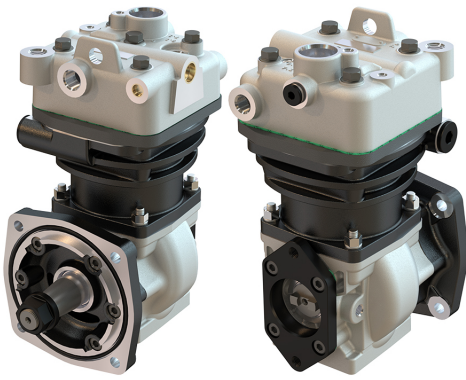
391.01.1000
Compressor (Single Cylinder)
Application: 300 cc

OEM	OE
LK3947	4261512
II17252	04266801
K040432N00	4220867

Cylinder Bore	Ø88
Stroke	50 mm
Swept Volume	300 cc
Air Inlet Port Size	Ø29,00
Air Delivery Port Size	M18*1,5
Number of Cylinders	1
Through Drive	YES
Unloader Port Size	M22*1,5
Water Or Air Cooled	W
Water Inlet Port Size	M16*1,5
Water Delivery Port Size	M16*1,5
Water Cooled Valve Plate	YES

Components

130.01.1100 Crankcase

OEM	OE
180411	

130.01.1200 Cylinder Head

OEM	OE
II162440061	1699823

130.01.1210 Cylinder Head With Plate Kit

OEM	OE

130.01.1300 Plate Kit

OEM	OE
II14777004	1699825

130.01.1400 Connecting Rod

OEM	OE
I60599	1698852
B80110	0001311817
	81541060013

391.01.1500 Crankshaft

OEM	OE

391.01.1650 Front Flange

OEM	OE

130.01.2600 Bushing

OEM	OE
B44935	1309548
B64572	0001313050
	0001313950
	81541300009

130.01.2610 Bushing

OEM	OE
B44935	0001313150
B64572	81541300007

130.01.2700 Screw Kit

OEM	OE

110.01.1700 Piston With Rings (STD)

110.01.1700-Ø88.00 mm
 110.01.1710-Ø88.25 mm
 110.01.1720-Ø88.50 mm
 110.01.1730-Ø88.75 mm
 110.01.1740-Ø89.00 mm

OEM	OE
SEB22555	1361265
I81169004	1409318
	1698848
	3095841
	51541036001
	81541190007
	85101375

110.01.1800 Piston Ring Kit (STD)

110.01.1800-Ø88.00 mm
 110.01.1810-Ø88.25 mm
 110.01.1820-Ø88.50 mm
 110.01.1830-Ø88.75 mm
 110.01.1840-Ø89.00 mm

OEM	OE
I811690062	3097153
II39526F0061	85100626

130.01.2300 Repair Kit With Bushing

OEM	OE

130.01.2350 Repair Kit w/o Bushing

OEM	OE

130.01.2330 Repair Kit

OEM	OE

130.01.2320 Repair Kit

OEM	OE

130.01.1280 Head Repair Kit

OEM	OE

130.01.2100 Gasket & Sealing Kit

OEM	OE
II147860051 II186060052	1699822

130.01.2200 Valve Kit

OEM	OE
II326830061 II86040061	3091592 3091593

130.01.2500 Unloader Valve Kit

OEM	OE
II159920063	3097147

130.01.2800 Cylinder Liner

OEM	OE
K000998	

130.01.2810 Cylinder Liner Kit

OEM	OE
K000998 I808640061	

391.01.3300 Pump Support

OEM	OE

OEM	OE

OEM	OE

OEM	OE

OEM	OE

OEM	OE

OEM	OE

OEM	OE

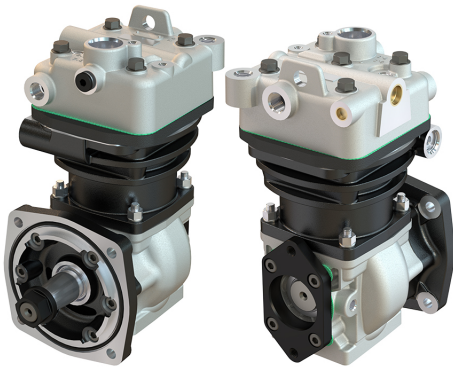
392.01.1000
Compressor (Single Cylinder)
Application: 300 cc

OEM	OE
LK3959	4261513
LK3985	4261514
II30892	4223949
K000741	4222619

Cylinder Bore	Ø88
Stroke	50 mm
Swept Volume	300 cc
Air Inlet Port Size	Ø29,00
Air Delivery Port Size	M18*1,5
Number of Cylinders	1
Through Drive	YES
Unloader Port Size	M22*1,5
Water Or Air Cooled	W
Water Inlet Port Size	M16*1,5
Water Delivery Port Size	M16*1,5
Water Cooled Valve Plate	YES

Components

130.01.1100 Crankcase

	OEM	OE
	I80411	

130.01.1200 Cylinder Head

	OEM	OE
	II162440061	1699823

130.01.1210 Cylinder Head With Plate Kit

	OEM	OE
		

130.01.1300 Plate Kit

	OEM	OE
	II14777004	1699825

130.01.1400 Connecting Rod

	OEM	OE
	I60599 B80110	1698852 0001311817 81541060013

391.01.1500 Crankshaft

	OEM	OE
		

391.01.1650 Front Flange

	OEM	OE
		

130.01.2600 Bushing

	OEM	OE
	B44935 B64572	1309548 0001313050 0001313950 81541300009

130.01.2610 Bushing

	OEM	OE
	B44935 B64572	0001313150 81541300007

130.01.2700 Screw Kit

	OEM	OE
		

110.01.1700 Piston With Rings (STD)

	OEM	OE
	SEB22555 I81169004	1361265 1409318 1698848 3095841 51541036001 81541190007 85101375
110.01.1700-Ø88.00 mm		
110.01.1710-Ø88.25 mm		
110.01.1720-Ø88.50 mm		
110.01.1730-Ø88.75 mm		
110.01.1740-Ø89.00 mm		

110.01.1800 Piston Ring Kit (STD)

	OEM	OE
	I811690062 II39526F0061	3097153 85100626
110.01.1800-Ø88.00 mm		
110.01.1810-Ø88.25 mm		
110.01.1820-Ø88.50 mm		
110.01.1830-Ø88.75 mm		
110.01.1840-Ø89.00 mm		

130.01.2300 Repair Kit With Bushing

	OEM	OE

130.01.2350 Repair Kit w/o Bushing

	OEM	OE

130.01.2330 Repair Kit

	OEM	OE

130.01.2320 Repair Kit

	OEM	OE

130.01.1280 Head Repair Kit

	OEM	OE

130.01.2100 Gasket & Sealing Kit

	OEM	OE
	I1147860051 I1186060052	1699822

130.01.2200 Valve Kit

	OEM	OE
	I1326830061 I186040061	3091592 3091593

130.01.2500 Unloader Valve Kit

	OEM	OE
	I1159920063	3097147

130.01.2800 Cylinder Liner

	OEM	OE
	K000998	

130.01.2810 Cylinder Liner Kit

	OEM	OE
	K000998 I1808640061	

391.01.3300 Pump Support

	OEM	OE

	OEM	OE

	OEM	OE

	OEM	OE

	OEM	OE

	OEM	OE

	OEM	OE

	OEM	OE

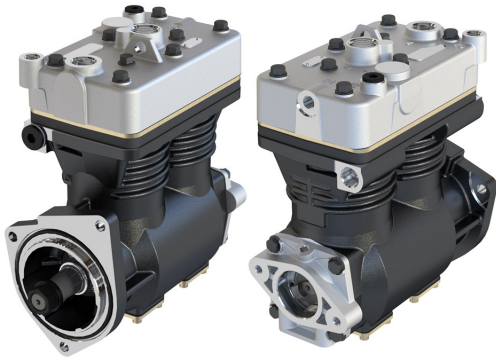
410.01.1000
Compressor (Twin Cylinder)
Application: 608 cc

OEM	OE
LP4961	971025
II30900	T25104499
	01180445

Cylinder Bore	Ø88
Stroke	50 mm
Swept Volume	608 cc
Air Inlet Port Size	M30*1,5
Air Delivery Port Size	M26*1,5
Number of Cylinders	2
Through Drive	YES
Unloader Port Size	M22*1,5
Water Or Air Cooled	W
Water Inlet Port Size	M16*1,5
Water Delivery Port Size	M16*1,5
Water Cooled Valve Plate	YES

Components

410.01.1100 Crankcase

OEM	OE

410.01.1200 Cylinder Head

OEM	OE
SEB01429004	

410.01.1210 Cylinder Head With Plate Kit

OEM	OE

110.01.1400 Connecting Rod

OEM	OE
SEB00967004	3097151

410.01.1500 Crankshaft

OEM	OE

107.01.1600 Bearing Cover

OEM	OE

102.01.2600 Bushing



OEM	OE
EB00819	1315274 1697278 1697286 5001830853 1697286

102.01.1580 Nut For Crankshaft

OEM	OE
	464642 1315273 1698672 1698672 464642

110.01.2700 Screw Kit

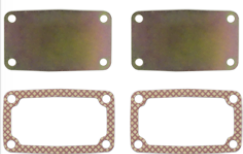
OEM	OE

102.01.1900 Bottom Cover Kit

OEM	OE
EB01058	1283816 1697772

110.01.1700 Piston With Rings (STD)

OEM	OE
SEB22555 I81169004	1361265 1409318 1698848 3095841 51541036001 81541190007 85101375

110.01.1700-Ø88.00 mm
110.01.1710-Ø88.25 mm
110.01.1720-Ø88.50 mm
110.01.1730-Ø88.75 mm
110.01.1740-Ø89.00 mm

110.01.1800 Piston Ring Kit (STD)

OEM	OE
I811690062 II39526F0061	3097153 85100626

110.01.1800-Ø88.00 mm
110.01.1810-Ø88.25 mm
110.01.1820-Ø88.50 mm
110.01.1830-Ø88.75 mm
110.01.1840-Ø89.00 mm

112.01.2300 Repair Kit With Bushing

OEM	OE

112.01.2350 Repair Kit w/o Bushing

OEM	OE
SEB22560 SEB22596	

112.01.2330 Repair Kit

OEM	OE

112.01.2320 Repair Kit

OEM	OE

110.01.1280 Head Repair Kit

OEM	OE

112.01.2100 Gasket & Sealing Kit

OEM	OE
SEB22561	1376281 1542159 3097143

110.01.1300 Plate Kit

OEM	OE
SEB01033004	1376272 3097146

112.01.1310 Plate Kit, Complete

OEM	OE

110.01.2200 Valve Kit

OEM	OE
SEB01138004 I1326840061	1376280 1391386 3091718 3091739

102.01.2500 Unloader Valve Kit

OEM	OE
I1159920063	1376279 3097147

OEM	OE

OEM	OE

OEM	OE

OEM	OE

OEM	OE

OEM	OE

OEM	OE

OEM	OE

437.01.1000
Compressor (Single Cylinder)
Application: 293 cc

OEM	OE
4111438450	1173859

Cylinder Bore	Ø90
Stroke	46 mm
Swept Volume	293 cc
Air Inlet Port Size	M26*1,5
Air Delivery Port Size	M26*1,5
Number of Cylinders	1
Through Drive	YES
Unloader Port Size	-
Water Or Air Cooled	A
Water Inlet Port Size	-
Water Delivery Port Size	-
Water Cooled Valve Plate	NO

Components

246.01.1100 Crankcase

	OEM	OE

246.01.1200 Cylinder Head

	OEM	OE
	4111426514	

246.01.1210 Cylinder Head With Plate Kit

	OEM	OE

246.01.1300 Plate Kit

	OEM	OE
	4121425012	

246.01.1400 Connecting Rod

	OEM	OE
	4111437362	

246.01.1500 Crankshaft

	OEM	OE
	4111436904	

326.01.1600 Bearing Cover

	OEM	OE
	4111406622 4111419232	0001312432

129.01.1600 Bearing Cover

	OEM	OE

130.01.2600 Bushing

	OEM	OE
	B44935 B64572	1309548 0001313050 0001313950 81541300009

279.01.2700 Screw Kit

	OEM	OE

246.01.1700 Piston With Rings (STD)

	OEM	OE
246.01.1700-Ø90.00 mm		
246.01.1710-Ø90.25 mm		
246.01.1720-Ø90.50 mm		
246.01.1730-Ø90.75 mm		
246.01.1740-Ø91.00 mm		

340.01.1800 Piston Ring Kit (STD)

	OEM	OE
	4111426232	
340.01.1800-Ø90.00 mm		
340.01.1810-Ø90.25 mm		
340.01.1820-Ø90.50 mm		
340.01.1830-Ø90.75 mm		
340.01.1840-Ø91.00 mm		

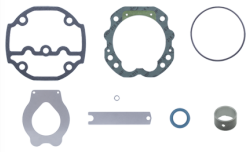
246.01.2300 Repair Kit With Bushing	
OEM	OE
	

246.01.2350 Repair Kit w/o Bushing	
OEM	OE
	

246.01.1280 Head Repair Kit	
OEM	OE
	

246.01.2100 Gasket & Sealing Kit	
OEM	OE
	

340.01.2200 Valve Kit	
OEM	OE
	

OEM	OE

OEM	OE

OEM	OE

OEM	OE

OEM	OE

OEM	OE

OEM	OE

OEM	OE

OEM	OE

OEM	OE

OEM	OE

OEM	OE

OEM	OE

457.01.1000

Compressor (Single Cylinder)

Application: 229 cc



OEM	OE
4111460030	4428408 G716880010010

Cylinder Bore	Ø100
Stroke	50 mm
Swept Volume	393 cc
Air Inlet Port Size	M26x1.5
Air Delivery Port Size	M26*1,5
Number of Cylinders	1
Through Drive	Yes
Unloader Port Size	-
Water Or Air Cooled	A
Water Inlet Port Size	-
Water Delivery Port Size	-
Water Cooled Valve Plate	NO

Components

246.01.1700 Piston With Rings (STD)

OEM	OE

246.01.1700-Ø90.00 mm
246.01.1710-Ø90.25 mm
246.01.1720-Ø90.50 mm
246.01.1730-Ø90.75 mm
246.01.1740-Ø91.00 mm

340.01.1800 Piston Ring Kit (STD)

OEM	OE
4111426232	

340.01.1800-Ø90.00 mm
340.01.1810-Ø90.25 mm
340.01.1820-Ø90.50 mm
340.01.1830-Ø90.75 mm
340.01.1840-Ø91.00 mm

457.01.2350 Repair Kit w/o Bushing

OEM	OE

457.01.1280 Head Repair Kit

OEM	OE

457.01.2100 Gasket & Sealing Kit

OEM	OE

340.01.2200 Valve Kit

OEM	OE

OEM	OE

OEM	OE

OEM	OE

OEM	OE

OEM	OE

OEM	OE

472.01.1000

Compressor (Twin Cylinder)

Application: 608 cc

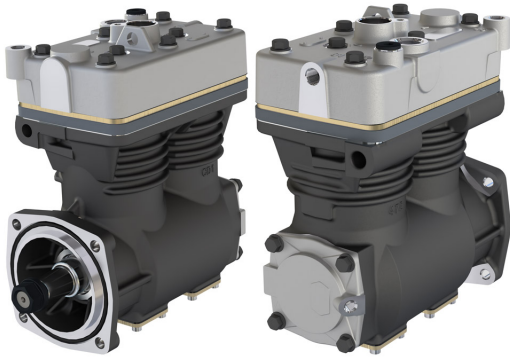

OEM	OE
LK4927 II39523F	04227086

Cylinder Bore	Ø88
Stroke	50 mm
Swept Volume	608 cc
Air Inlet Port Size	Ø29,00
Air Delivery Port Size	M26*1,5
Number of Cylinders	2
Through Drive	YES
Unloader Port Size	M22*1,5
Water Or Air Cooled	W
Water Inlet Port Size	M16*1,5
Water Delivery Port Size	M16*1,5
Water Cooled Valve Plate	YES

Components

472.01.1100 Crankcase



OEM	OE

123.01.1200 Cylinder Head



OEM	OE
SEB01551004	3095839

123.01.1210 Cylinder Head With Plate Kit



OEM	OE

116.01.1300 Plate Kit

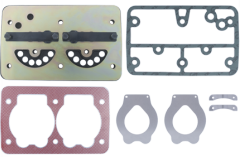

OEM	OE
SEB01034004	1361262 3095845

110.01.1400 Connecting Rod



OEM	OE
SEB00967004	3097151

112.01.1500 Crankshaft



OEM	OE
EB01831 2EB017531	

102.01.1580 Nut For Crankshaft



OEM	OE
	464642 1315273 1698672 1698672 464642

110.01.1600 Bearing Cover

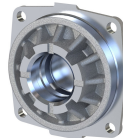

OEM	OE
II159920065	1376275 3097150

110.01.1700 Piston With Rings (STD)



110.01.1700-Ø88.00 mm
110.01.1710-Ø88.25 mm
110.01.1720-Ø88.50 mm
110.01.1730-Ø88.75 mm
110.01.1740-Ø89.00 mm

OEM	OE
SEB22555 I81169004	1361265 1409318 1698848 3095841 51541036001 81541190007 85101375

110.01.1800 Piston Ring Kit (STD)



110.01.1800-Ø88.00 mm
110.01.1810-Ø88.25 mm
110.01.1820-Ø88.50 mm
110.01.1830-Ø88.75 mm
110.01.1840-Ø89.00 mm

OEM	OE
I811690062 II39526F0061	3097153 85100626

102.01.1900 Bottom Cover Kit

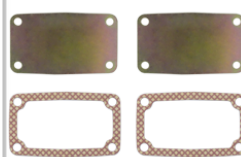

OEM	OE
EB01058	1283816 1697772

102.01.2600 Bushing



OEM	OE
EB00819	1315274 1697278 1697286 5001830853 1697286

110.01.2700 Screw Kit		
	OEM	OE
		

116.01.1280 Head Repair Kit		
	OEM	OE
		

116.01.2200 Valve Kit		
	OEM	OE
		

	OEM	OE

	OEM	OE

	OEM	OE

	OEM	OE

	OEM	OE

	OEM	OE

	OEM	OE

	OEM	OE

	OEM	OE

	OEM	OE

	OEM	OE

	OEM	OE

	OEM	OE

	OEM	OE

	OEM	OE

534.01.1000

Compressor (Single Cylinder)

Application: DEUTZ OTOKAR SULTAN 125

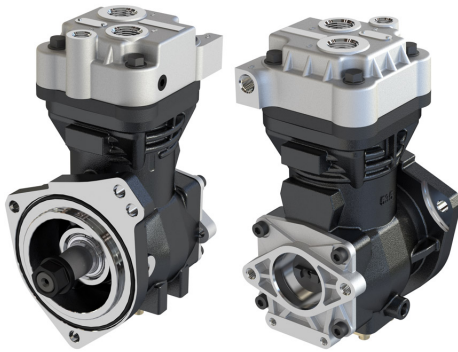

OEM	OE
LK3866	04298359
K018385	
K018385000	
K018385ES	

Cylinder Bore	Ø80
Stroke	45 mm
Swept Volume	225 cc
Air Inlet Port Size	M26*1,5
Air Delivery Port Size	M26*1,5
Number of Cylinders	1
Through Drive	YES
Unloader Port Size	-
Water Or Air Cooled	W
Water Inlet Port Size	M16*1,5
Water Delivery Port Size	M16*1,5
Water Cooled Valve Plate	YES

Components

534.01.1100 Crankcase

	OEM	OE

534.01.1200 Cylinder Head

	OEM	OE
	K006024	

534.01.1210 Cylinder Head With Plate Kit

	OEM	OE

534.01.1300 Plate Kit

	OEM	OE
	SEB01938004	

409.01.1400 Connecting Rod

	OEM	OE
	SEB22464	85104324

534.01.1500 Crankshaft

	OEM	OE

534.01.1600 Bearing Cover

	OEM	OE

120.01.2200 Valve Kit

	OEM	OE

102.01.2600 Bushing

	OEM	OE
	EB00819	1315274 1697278 1697286 5001830853 1697286

120.01.2700 Screw Kit

	OEM	OE

120.01.1700 Piston With Rings (STD)

	OEM	OE
	SEB22517 SEB01594004	1452718 1844254 42549206 85104325 7421136656 9P918388
	120.01.1700-Ø80.00 mm	
	120.01.1710-Ø80.25 mm	
	120.01.1720-Ø80.50 mm	
	120.01.1730-Ø80.75 mm	
	120.01.1740-Ø81.00 mm	

120.01.1800 Piston Ring Kit (STD)

	OEM	OE
	SEB22463	
	120.01.1800-Ø80.00 mm	
	120.01.1810-Ø80.25 mm	
	120.01.1820-Ø80.50 mm	
	120.01.1830-Ø80.75 mm	
	120.01.1840-Ø81.00 mm	

534.01.2300 Repair Kit With Bushing	
OEM	OE

534.01.2350 Repair Kit w/o Bushing	
OEM	OE

534.01.1280 Head Repair Kit	
OEM	OE

534.01.2100 Gasket & Sealing Kit	
OEM	OE

OEM	OE

OEM	OE

OEM	OE

OEM	OE

OEM	OE

OEM	OE

OEM	OE

OEM	OE

OEM	OE

OEM	OE

OEM	OE

OEM	OE

OEM	OE

OEM	OE

535.01.1000

Compressor (Single Cylinder)

Application: MIDLUM DXI 5 ENGINE / MIDLUM DXI 7 ENGINE

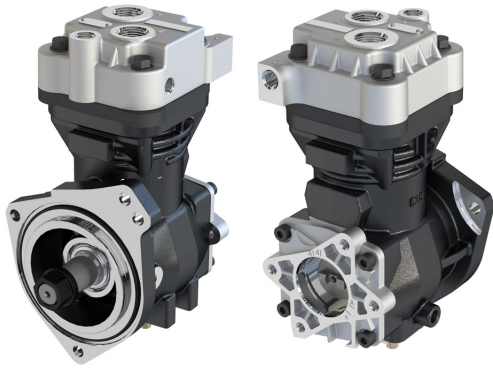

OEM	OE
LK3869	7485003044
K016932	21098900
K016932000	21098915
K016932C06	7421098915
K016932C56	04905010
K016932C57	
K016932N06	
K016932N56	
K016932N57	
K016932X00	

Cylinder Bore	Ø80
Stroke	45 mm
Swept Volume	225 cc
Air Inlet Port Size	M26*1,5
Air Delivery Port Size	M26*1,5
Number of Cylinders	1
Through Drive	YES
Unloader Port Size	-
Water Or Air Cooled	W
Water Inlet Port Size	M16*1,5
Water Delivery Port Size	M16*1,5
Water Cooled Valve Plate	YES

Components

534.01.1100 Crankcase



OEM	OE

535.01.1200 Cylinder Head



OEM	OE

535.01.1220 Cylinder Upper Head



OEM	OE
K012234	7421136513

535.01.1230 Cylinder Lower Head



OEM	OE

535.01.1210 Cylinder Head With Plate Kit



OEM	OE

535.01.1300 Plate Kit

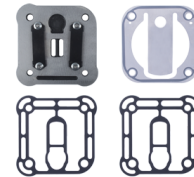

OEM	OE
SEB01938004	

409.01.1400 Connecting Rod



OEM	OE
SEB22464	85104324

534.01.1500 Crankshaft



OEM	OE

102.01.1580 Nut For Crankshaft



OEM	OE
	464642 1315273 1698672 1698672 464642

701.01.1600 Bearing Cover



OEM	OE

120.01.1700 Piston With Rings (STD)



OEM	OE
SEB22517	1452718
SEB01594004	1844254 42549206 85104325 7421136656 9P918388

120.01.1700-Ø80.00 mm
120.01.1710-Ø80.25 mm
120.01.1720-Ø80.50 mm
120.01.1730-Ø80.75 mm
120.01.1740-Ø81.00 mm

120.01.1800 Piston Ring Kit (STD)



OEM	OE
SEB22463	

120.01.1800-Ø80.00 mm
120.01.1810-Ø80.25 mm
120.01.1820-Ø80.50 mm
120.01.1830-Ø80.75 mm
120.01.1840-Ø81.00 mm

535.01.2300 Repair Kit With Bushing

OEM	OE

535.01.2350 Repair Kit w/o Bushing

OEM	OE
K012252	

535.01.2320 Repair Kit

OEM	OE

535.01.1280 Head Repair Kit

OEM	OE

535.01.2100 Gasket & Sealing Kit

OEM	OE
K012252	

120.01.2200 Valve Kit

OEM	OE

102.01.2600 Bushing

OEM	OE
EB00819	1315274 1697278 1697286 5001830853 1697286

136.01.2700 Screw Kit

OEM	OE
8912119994	

186.06.100 Safety valve

OEM	OE
K015499	

OEM	OE

OEM	OE

OEM	OE

OEM	OE

OEM	OE

OEM	OE

OEM	OE

OEM	OE

OEM	OE

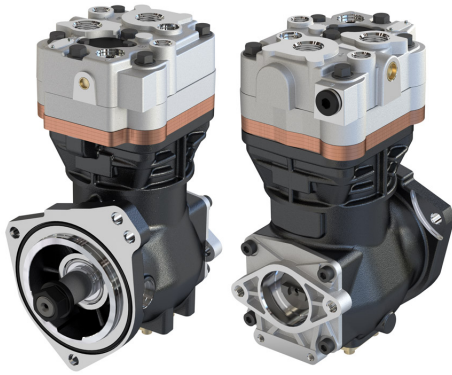
536.01.1000
Compressor (Single Cylinder)
Application: OTOKAR DORUK

OEM	OE
LP3955 K003084	04903511

Cylinder Bore	Ø92
Stroke	54 mm
Swept Volume	359 cc
Air Inlet Port Size	M26*1,5
Air Delivery Port Size	M26*1,5
Number of Cylinders	1
Through Drive	YES
Unloader Port Size	M10*1
Water Or Air Cooled	W
Water Inlet Port Size	M16*1,5
Water Delivery Port Size	M16*1,5
Water Cooled Valve Plate	YES

Components

536.01.1100 Crankcase

	OEM	OE

536.01.1200 Cylinder Head

	OEM	OE

536.01.1220 Cylinder Upper Head

	OEM	OE
	K011809	

441.01.1230 Cylinder Lower Head

	OEM	OE

536.01.1210 Cylinder Head With Plate Kit

	OEM	OE

441.01.1300 Plate Kit

	OEM	OE
	K011811	

409.01.1400 Connecting Rod

	OEM	OE
	SEB22464	85104324

536.01.1500 Crankshaft

	OEM	OE

534.01.1600 Bearing Cover

	OEM	OE

102.01.2600 Bushing

	OEM	OE
	EB00819	1315274 1697278 1697286 5001830853 1697286

122.01.1700 Piston With Rings (STD)

	OEM	OE
	SEB22530 K006026 K012079	21136690 7421136690 51541196008 51541196009
122.01.1700-Ø92.00 mm		
122.01.1710-Ø92.25 mm		
122.01.1720-Ø92.50 mm		
122.01.1730-Ø92.75 mm		
122.01.1740-Ø93.00 mm		

122.01.1800 Piston Ring Kit (STD)

	OEM	OE
122.01.1800-Ø92.00 mm		
122.01.1810-Ø92.25 mm		
122.01.1820-Ø92.50 mm		
122.01.1830-Ø92.75 mm		
122.01.1840-Ø93.00 mm		

536.01.2300 Repair Kit With Bushing

	OEM	OE

536.01.2350 Repair Kit w/o Bushing

K011818

	OEM	OE

536.01.2330 Repair Kit

	OEM	OE

536.01.2320 Repair Kit

	OEM	OE

441.01.1280 Head Repair Kit

	OEM	OE

536.01.2100 Gasket & Sealing Kit

	OEM	OE

441.01.2200 Valve Kit

	OEM	OE

670.01.2500 Unloader Valve Kit

K034874K50

	OEM	OE

441.01.2700 Screw Kit

	OEM	OE

	OEM	OE

	OEM	OE

	OEM	OE

	OEM	OE

	OEM	OE

	OEM	OE

	OEM	OE

	OEM	OE

	OEM	OE

537.01.1000

Compressor (Single Cylinder)

Application: 360 cc



OEM	OE
LK8905	04124820
LP3998	16H13-16708-AA
K011192	04909170
K040960N00	

Cylinder Bore	Ø92
Stroke	54 mm
Swept Volume	359 cc
Air Inlet Port Size	M26*1,5
Air Delivery Port Size	M26*1,5
Number of Cylinders	1
Through Drive	YES
Unloader Port Size	M10*1
Water Or Air Cooled	W
Water Inlet Port Size	M16*1,5
Water Delivery Port Size	M16*1,5
Water Cooled Valve Plate	YES

Components

536.01.1100 Crankcase



OEM	OE

536.01.1200 Cylinder Head



OEM	OE

536.01.1220 Cylinder Upper Head



OEM	OE
K011809	

441.01.1230 Cylinder Lower Head



OEM	OE

536.01.1210 Cylinder Head With Plate Kit



OEM	OE

441.01.1300 Plate Kit



OEM	OE
K011811	

409.01.1400 Connecting Rod



OEM	OE
SEB22464	85104324

536.01.1500 Crankshaft



OEM	OE

701.01.1600 Bearing Cover



OEM	OE

102.01.2600 Bushing



OEM	OE
EB00819	1315274 1697278 1697286 5001830853 1697286

122.01.1700 Piston With Rings (STD)



OEM	OE
SEB22530 K006026 K012079	21136690 7421136690 51541196008 51541196009

122.01.1700-Ø92.00 mm
122.01.1710-Ø92.25 mm
122.01.1720-Ø92.50 mm
122.01.1730-Ø92.75 mm
122.01.1740-Ø93.00 mm

122.01.1800 Piston Ring Kit (STD)



OEM	OE

122.01.1800-Ø92.00 mm
122.01.1810-Ø92.25 mm
122.01.1820-Ø92.50 mm
122.01.1830-Ø92.75 mm
122.01.1840-Ø93.00 mm

536.01.2300 Repair Kit With Bushing		OEM	OE

536.01.2350 Repair Kit w/o Bushing		OEM	OE
		K011818	

536.01.2330 Repair Kit		OEM	OE

536.01.2320 Repair Kit		OEM	OE

441.01.1280 Head Repair Kit		OEM	OE

536.01.2100 Gasket & Sealing Kit		OEM	OE

441.01.2200 Valve Kit		OEM	OE

670.01.2500 Unloader Valve Kit		OEM	OE
		K034874K50	

441.01.2700 Screw Kit		OEM	OE

186.06.100 Safety valve		OEM	OE
		K015499	

		OEM	OE

		OEM	OE

		OEM	OE

		OEM	OE

		OEM	OE

		OEM	OE

		OEM	OE

		OEM	OE

623.01.1000

Compressor (Twin Cylinder)

Application: OTOKAR DORUK



OEM	OE
LP4852	01181454
SEB01588	16F00-18110-AA
	01181453

Cylinder Bore	Ø75
Stroke	50 mm
Swept Volume	440 cc
Air Inlet Port Size	M26*1,5
Air Delivery Port Size	M26*1,5
Number of Cylinders	2
Through Drive	YES
Unloader Port Size	-
Water Or Air Cooled	W
Water Inlet Port Size	M16*1,5
Water Delivery Port Size	M16*1,5
Water Cooled Valve Plate	YES

Components

623.01.1100 Crankcase



OEM	OE

623.01.1200 Cylinder Head



OEM	OE

623.01.1210 Cylinder Head With Plate Kit



OEM	OE

105.01.1300 Plate Kit



OEM	OE
181015004	1315372
1810150061	1315377
	1697290
	1697770

102.01.1400 Connecting Rod



OEM	OE
SEB00626004	1283811
SEB00957004	1315278
	3090386
	1697281
	1698528

623.01.1500 Crankshaft



OEM	OE

623.01.1600 Bearing Cover



OEM	OE

102.01.1580 Nut For Crankshaft



OEM	OE
	464642
	1315273
	1698672
	1698672
	464642

102.01.2600 Bushing



OEM	OE
EB00819	1315274
	1697278
	1697286
	5001830853
	1697286

102.01.2700 Screw Kit



OEM	OE

102.01.1700 Piston With Rings (STD)



102.01.1700-Ø75.00 mm
 102.01.1710-Ø75.25 mm
 102.01.1720-Ø75.50 mm
 102.01.1730-Ø75.75 mm
 102.01.1740-Ø76.00 mm

OEM	OE
SEB22539	1315279
SEB01511004	1433932
STW63843	1697282
	5001867688
	1315280
	5001867688

102.01.1800 Piston Ring Kit (STD)



102.01.1800-Ø75.00 mm
 102.01.1810-Ø75.25 mm
 102.01.1820-Ø75.50 mm
 102.01.1830-Ø75.75 mm
 102.01.1840-Ø76.00 mm

OEM	OE
4111416232	513839
1801770061	513843
8956710204	1283826
4111419202	1391384
	1391385
	1396835
	3090388
	0011310711

105.01.2300 Repair Kit With Bushing

OEM	OE
	1315376 1315377



105.01.2350 Repair Kit w/o Bushing

OEM	OE
SEB22541	

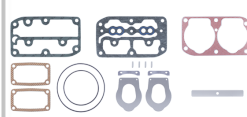

105.01.2320 Repair Kit

OEM	OE

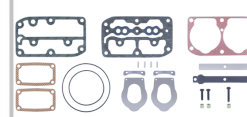

105.01.1280 Head Repair Kit

OEM	OE

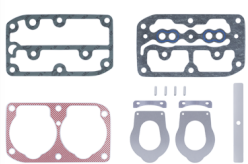

105.01.2100 Gasket & Sealing Kit

OEM	OE
SEB22542	

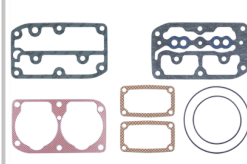

103.01.2200 Valve Kit

OEM	OE
11326840061	1283818 1317862



102.01.1900 Bottom Cover Kit

OEM	OE
EB01058	1283816 1697772



OEM	OE

OEM	OE

OEM	OE

OEM	OE

OEM	OE

OEM	OE

OEM	OE

OEM	OE

OEM	OE

OEM	OE

OEM	OE

765.01.1000

Compressor (Single Cylinder)

Application: 159 cc

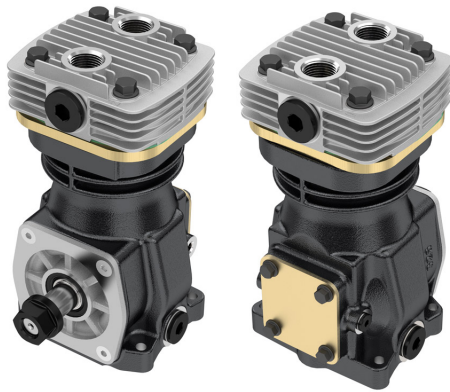

OEM	OE
4111410020	87773602 1505910 7700071622 04414768

Cylinder Bore	Ø75
Stroke	36 mm
Swept Volume	59 cc
Air Inlet Port Size	M26*1,5
Air Delivery Port Size	M26*1,5
Number of Cylinders	1
Through Drive	YES
Unloader Port Size	-
Water Or Air Cooled	A
Water Inlet Port Size	-
Water Delivery Port Size	-
Water Cooled Valve Plate	NO

Components

326.01.1100 Crankcase

	OEM	OE
		

326.01.1200 Cylinder Head

	OEM	OE
	4111416504	

326.01.1210 Cylinder Head With Plate Kit

	OEM	OE
	4111419262	

326.01.1300 Plate Kit

	OEM	OE
	4111415012	0001304920

326.01.1400 Connecting Rod

	OEM	OE
	4111417322	0001311517

326.01.1500 Crankshaft

	OEM	OE
	4111416904 4111416904 4111436904	0001313916

326.01.1600 Bearing Cover

	OEM	OE
	4111406622 4111419232	0001312432

326.01.1610 Bearing Cover

	OEM	OE
		

326.01.2200 Valve Kit

	OEM	OE
		

326.01.2600 Bushing

	OEM	OE
	4110423404	

218.01.1700 Piston With Rings (STD)

	OEM	OE
	4111416232	513860 8121570 9982648 5000816053 0001311607 81541190004 81541196039
218.01.1700-Ø75.00 mm		
218.01.1710-Ø75.25 mm		
218.01.1720-Ø75.50 mm		
218.01.1730-Ø75.75 mm		
218.01.1740-Ø76.00 mm		

102.01.1800 Piston Ring Kit (STD)

	OEM	OE
	4111416232 1801770061 8956710204 4111419202	513839 513843 1283826 1391384 1391385 1396835 3090388 0011310711
102.01.1800-Ø75.00 mm		
102.01.1810-Ø75.25 mm		
102.01.1820-Ø75.50 mm		
102.01.1830-Ø75.75 mm		
102.01.1840-Ø76.00 mm		

326.01.2300 Repair Kit With Bushing		
	OEM	OE
		

326.01.2350 Repair Kit w/o Bushing		
	OEM	OE
		

326.01.1280 Head Repair Kit		
	OEM	OE
		

326.01.2100 Gasket & Sealing Kit		
	OEM	OE
		

	OEM	OE

	OEM	OE

	OEM	OE

	OEM	OE

	OEM	OE

	OEM	OE

	OEM	OE

	OEM	OE

	OEM	OE

	OEM	OE

	OEM	OE

	OEM	OE

	OEM	OE

	OEM	OE

771.01.1000
Compressor (Single Cylinder)
Application: 159 cc

OEM	OE
4111418450	1173877
4111418350	763056
	4788302
	F255880010010
	1070323
	1261659
	42522657
	1416530
	841845630
	1173863
	01172867
	01172874
	01173876
	42017954
	42522658
	1173864

Cylinder Bore	Ø75
Stroke	36
Swept Volume	159
Air Inlet Port Size	M26x1,5
Air Delivery Port Size	M26x1,5
Number of Cylinders	1
Through Drive	Yes
Unloader Port Size	-
Water Or Air Cooled	A
Water Inlet Port Size	-
Water Delivery Port Size	-
Water Cooled Valve Plate	NO

Components

771.01.1100 Crankcase

OEM	OE

771.01.1200 Cylinder Head

OEM	OE
4111416524	

771.01.1210 Cylinder Head With Plate Kit



OEM	OE
4111419262	

326.01.1300 Plate Kit

OEM	OE
4111415012	0001304920

326.01.1310 Plate Kit, Complete

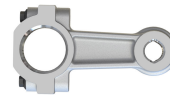
OEM	OE

326.01.1400 Connecting Rod

OEM	OE
4111417322	0001311517

326.01.1470 Connecting Rod & Piston Rep Kit

OEM	OE
4111419272	

326.01.1500 Crankshaft

OEM	OE
4111416904	0001313916
4111416904	
4111436904	

326.01.1600 Bearing Cover

OEM	OE
4111406622	0001312432
4111419232	

326.01.2600 Bushing

OEM	OE
4110423404	

218.01.1700 Piston With Rings (STD)



218.01.1700-Ø75.00 mm
 218.01.1710-Ø75.25 mm
 218.01.1720-Ø75.50 mm
 218.01.1730-Ø75.75 mm
 218.01.1740-Ø76.00 mm

OEM	OE
4111416232	513860
	8121570
	9982648
	5000816053
	0001311607
	81541190004
	81541196039

102.01.1800 Piston Ring Kit (STD)



102.01.1800-Ø75.00 mm
 102.01.1810-Ø75.25 mm
 102.01.1820-Ø75.50 mm
 102.01.1830-Ø75.75 mm
 102.01.1840-Ø76.00 mm

OEM	OE
4111416232	513839
1801770061	513843
8956710204	1283826
4111419202	1391384
	1391385
	1396835
	3090388
	0011310711

326.01.2300 Repair Kit With Bushing		
	OEM	OE
		

326.01.2350 Repair Kit w/o Bushing		
	OEM	OE
		

326.01.1280 Head Repair Kit		
	OEM	OE
		

326.01.2100 Gasket & Sealing Kit		
	OEM	OE
		

326.01.2200 Valve Kit		
	OEM	OE
		

	OEM	OE

	OEM	OE

	OEM	OE

	OEM	OE

	OEM	OE

	OEM	OE

	OEM	OE

	OEM	OE

	OEM	OE

	OEM	OE

	OEM	OE

	OEM	OE

	OEM	OE